

User Manual

SmartyCam 3 Series Release 1.15





INDEX

- 1 – SmartyCam 3 preliminary notes..... 3
- 2 – SmartyCam 3 topics 4
- 3 – SmartyCam 3 connections 7
- 4 – SmartyCam 3 buttons, ON/OFF, powering and LEDs 14
 - 4.1 – Pushbuttons 14
 - 4.2 – Power ON/OFF and battery status 16
 - 4.2.1 – Power ON/OFF 16
 - 4.2.2 – Battery Status 17
 - 4.3 – LEDs working mode (all SmartyCam 3 except for SmartyCam 3 Sport) 18
 - 4.3.1 – Working Mode of SmartyCam 3 Dual front LEDs 18
 - 4.3.2 – Working Mode of SmartyCam 3 GP, SmartyCam 3 GP Pro and SmartyCam 3 Corsa LED..... 19
- 5 – (Micro) SD card management 20
- 6 – SmartyCam 3 Start/Stop recording 21
- 7 – SmartyCam 3 Menu 22
 - 7.1 – GPS Status 22
 - 7.2 – Tracks 23
 - 7.2.1 – Loading tracks to SmartyCam 3 24
 - 7.2.2 – Managing tracks on SmartyCam 3 25
 - 7.3 – Settings 26
 - 7.3.1 – Auto Start Rec 26
 - 7.3.2 – Auto Stop Rec 26
 - 7.3.3 – Auto power off 26
 - 7.3.4 – Key settings (SmartyCam 3 Dual and SmartyCam 3 GP only) 27
 - 7.3.5 – System time 27
 - 7.3.6 – Video Set (SmartyCam 3 GP only) 27
 - 7.3.7 – Exposure set 28
 - 7.3.8 – Audio set 29
 - 7.3.9 – Video Out (SmartyCam 3 Dual and SmartyCam 3 GP only) 30
 - 7.3.10 – Export LOGS..... 30
 - 7.3.11 – Export Conf (SmartyCam 3 GP and SmartyCam 3 Dual only) 30
 - 7.3.12 – Clear tracks 30
 - 7.3.13 – Factory reset 30
 - 7.3.14 – Rec Counter 30
 - 7.3.15 – Overlay 31
 - 7.3.16 – Flip over (SmartyCam 3 Sport and SmartyCam 3 Corsa only)..... 31
 - 7.3.17 – Info 32
 - 7.4 – Update 32
 - 7.4.1 – Firmup 33
 - 7.4.2 – Tracks update 34
 - 7.5 – Video file 34
- 8 – SmartyCam 3 and the PC 35
 - 8.1 – Creating SmartyCam 3 configuration 35
 - 8.1.1 – Configuring SmartyCam 3 overlay 37
 - 8.1.2 – Logos & MAP and second camera (SmartyCam 3 dual only) setting 39
 - 8.1.3 – Configuring SmartyCam 3 parameters for start recording 40
 - 8.1.4 – Configuring CAN Protocol (SmartyCam 3 connected to a master only) 41
 - 8.1.5 – ECU Stream (all SmartyCam 3 except for SmartyCam 3 Sport) 44
 - 8.2 – Loading the configuration to SmartyCam 3 45
 - 8.3 – Track Management 46
 - 8.4 – Video Management..... 48
- 9 – Technical specifications and drawings 51
 - 9.1 – Technical Specifications 51
 - 9.2 – Drawings 54
 - 9.2.1 – SmartyCam 3 Sport..... 54
 - 9.2.2 – SmartyCam 3 Dual 56
 - 9.2.3 – SmartyCam 3 GP..... 60



9.2.4 – SmartyCam 3 GP Pro 64
9.2.5 – SmartyCam 3 Corsa 66

1 – SmartyCam 3 preliminary notes

This manual is intended to explain how to configure and use all versions of the new SmartyCam 3 action camera. The models are deeply different; and are intended for completely different applications; but share the same philosophy, configuration logic, operating system and internal components. In the following pages the explanations will be intended for all models, when not otherwise specified.



SmartyCam 3 Sport



SmartyCam 3 Corsa



SmartyCam 3 Dual

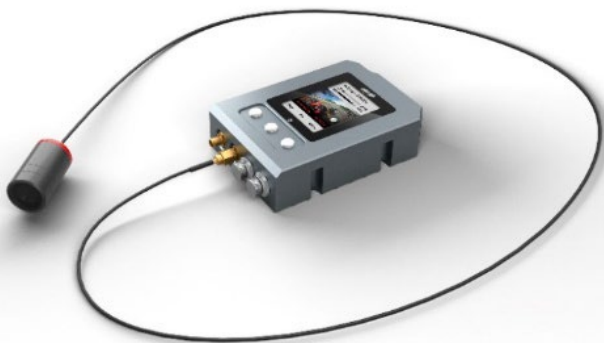

SmartyCam 3 GP



SmartyCam 3 GP Pro



2 – SmartyCam 3 topics

Wide Global Shutter CMOS sensor

The best way to avoid wave effects when vibrations are strong.



Standard action camera

Full HD image

1920 x 1080 resolution

SmartyCam 3 Sport records video at 30 fps

SmartyCam 3 Dual and GP records video at 30 or 60 fps.

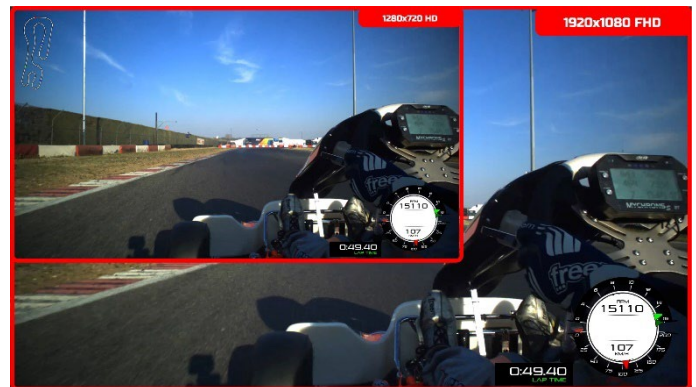

Completely waterproof

Designed for being used in the hardest environments: water, dust, temperatures are not a problem.

Sapphire frontal glass

The strongest glass for facing all high-speed impacts with pebbles, insects, dust that usually happen in a race.





A lot of graphic controls

Choose your preferred layout for keeping your data under control

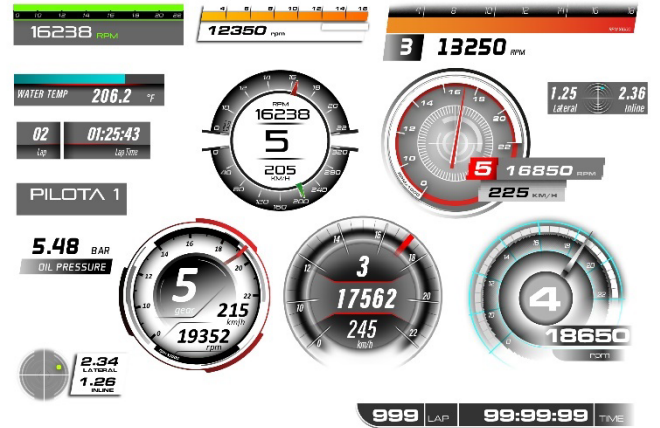

Secondary Camera (SmartyCam 3 Dual only)

Using Race Studio 3 software (supported from release 3.53.xx onward) you can place the video coming from the second camera where you prefer on the video, exactly as if you were adding any graphic control.



Bullet camera (SmartyCam 3 GP and SmartyCam 3 GP Pro only)

This camera features a bullet camera whose connection cable to the main module can be from 0.5 to 4m long. It allows the user to install the camera on a bike or on a kart. This camera too needs to be configured with AiM Race Studio 3 software from release 3.57.00 onward.





Additional internal memory (SmartyCam 3 GP Pro only)

In addition to the normal SD Card, **SmartyCam 3 GP Pro** features a 64 GB internal memory. This second memory is “round”; this means that when the memory is full older files are overwritten. **Please note: no warning is given to the user.**

Auto start/stop recording

Avoid thinking at the camera while ready at the start/finish line.

Automatic track selection

SmartyCam 3 may work connected to an AiM Logger or in a standalone installation: in the first case, it receives the track selected by the logger, while in the second case it automatically selects the proper track using the information coming from the GPS Module. In this way, it can draw the map and calculate lap number, lap times and rolling times.

Video and data in the same file

Your video and the most important data in the same MP4 file.

Video Output (SmartyCam 3 Dual, SmartyCam 3 GP and SmartyCam 3 GP Pro only)

SmartyCam 3 Dual, SmartyCam 3 GP and SmartyCam 3 GP Pro feature a Video output that can be connected to an external video streamer.

Automatic data and video synchronization

MP4 file stores the data SmartyCam 3 receives: in case they are not enough for your analysis, simply import into Analysis 3 both the video file and the data from your AiM logger and the software will automatically synchronize them: position on the track, video frame and data on the graph will be perfectly correlated

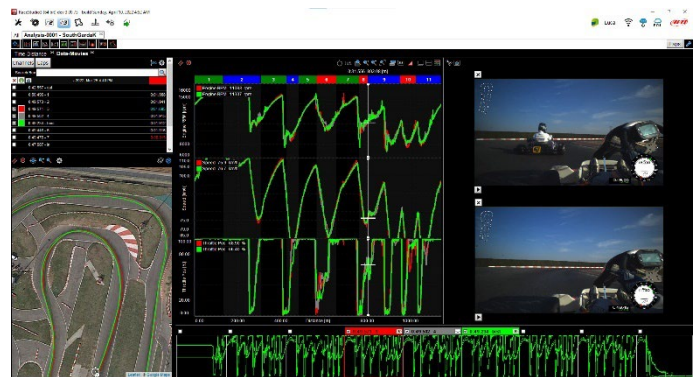

3 – SmartyCam 3 connections

SmartyCam 3 has an internal battery that may keep the system alive for a few minutes (around 20 min), so it is important to power it through an external 12 Volt battery. Here below you see some SmartyCam 3 connections.

To connect **SmartyCam 3 Sport** to GPS Module use the 5 pins Binder 712 female connector you find back on the camera and connect it to the 2 ways Data Hub needed to power the camera.



To connect **SmartyCam 3 Dual** to GPS Module use the "EXP" cable of 22 pins Deutsch female connector harness.

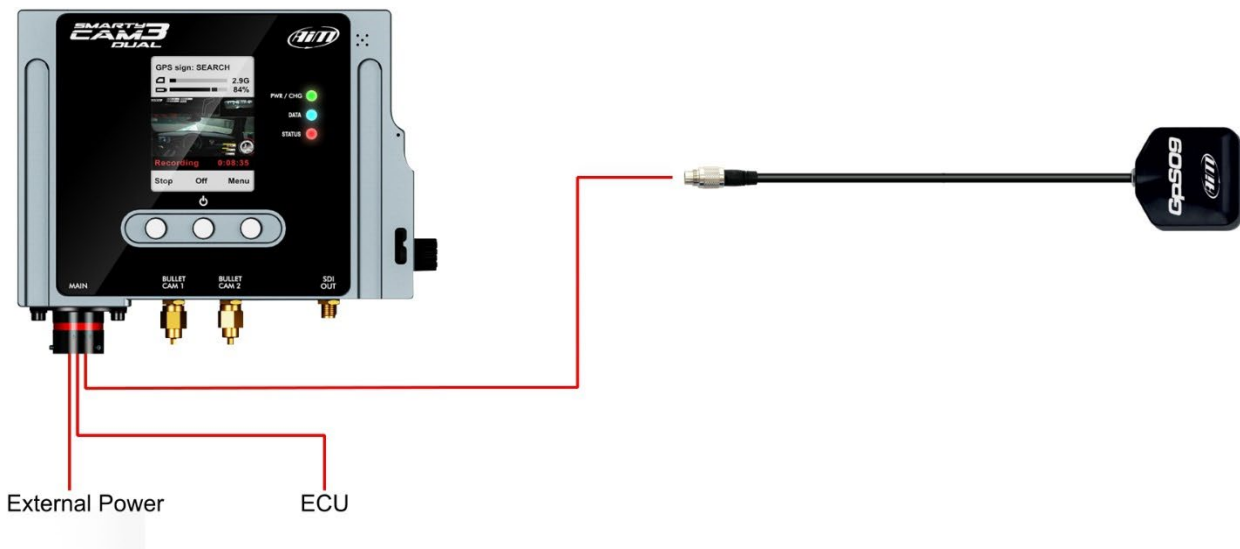

To connect **SmartyCam 3 GP** to GPS Module use the 5 pins Binder 712 female connector labelled "EXP".
To connect **SmartyCam 3 GP Pro** to GPS Module use the 5 pins Deutsch male connector (blue key) labelled "EXP".

SmartyCam 3 GP and
SmartyCam 3 GP Pro



To connect **SmartyCam 3 Corsa** to GPS Module use the 5 pins Binder connector labelled "GPS".





SmartyCam 3 can as well be connected to AiM Dashes and loggers through the AiM CAN network. The images below show some examples of connection.



SmartyCam 3 GP and
SmartyCam 3 GP Pro



External Power

ECU



External Power

ECU



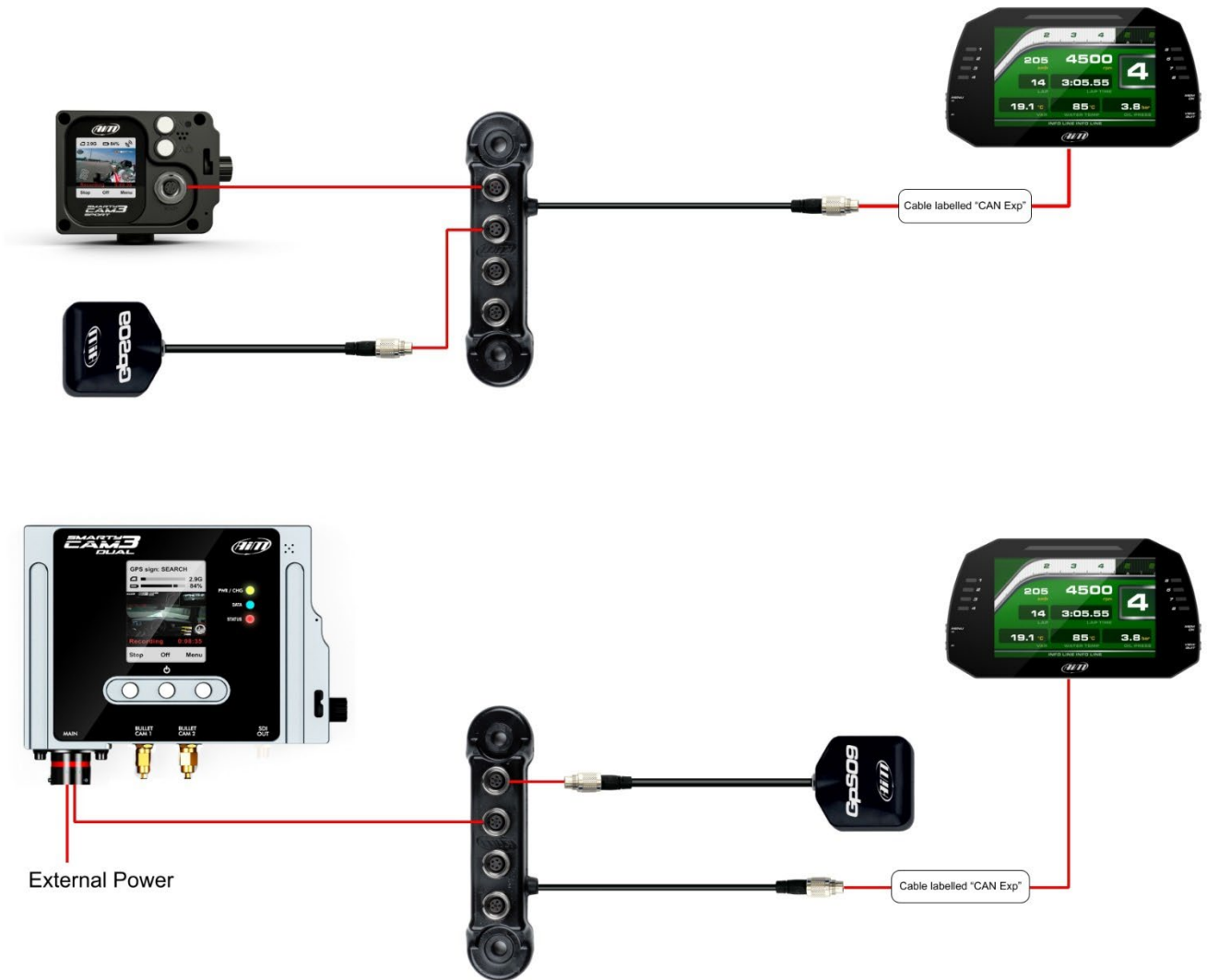

SmartyCam 3 GP and
SmartyCam 3 GP Pro

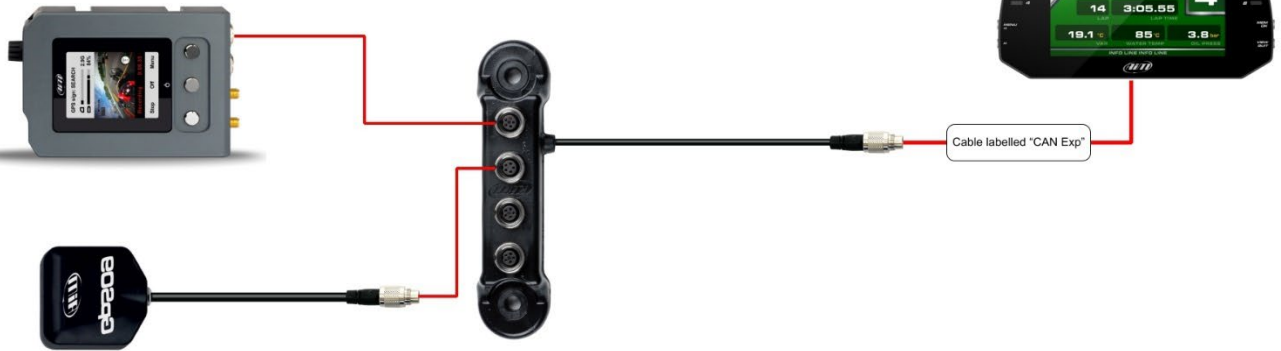

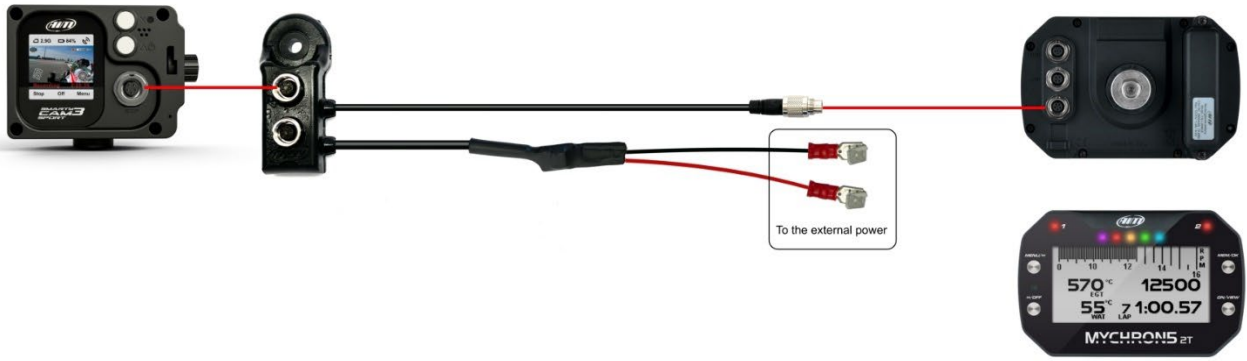

SmartyCam 3 GP e
SmartyCam 3 GP Pro

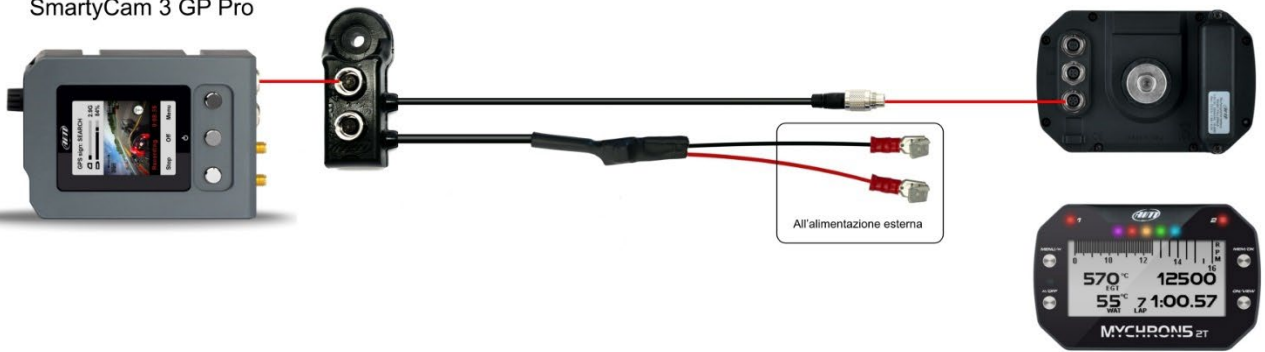

4 – SmartyCam 3 buttons, ON/OFF, powering and LEDs

4.1 – Pushbuttons

SmartyCam 3 Sport features two metal pushbuttons on its back, each of which manages two different features, in accordance to what shown in the display.



* Long pressure > 0.5 seconds
Short pressure < 0.5 seconds

The upper pushbutton manages the features corresponding to these icons:

- "X": short pressure
- ●: long pressure

While the lower pushbutton manages the features corresponding to these icons:

- △: short pressure
- ⏻: long pressure to turn OFF

SmartyCam 3 Dual, SmartyCam 3 GP, SmartyCam 3 GP Pro and SmartyCam 3 Corsa feature three metal pushbuttons on its front: the central one switches on/off the camera. The two lateral buttons working mode is indicated by the menu written bottom in the display.

SmartyCam 3 GP and SmartyCam 3 GP Pro



Switch on/off



Switch on/off



4.2 – Power ON/OFF and battery status

SmartyCam needs to be powered by an external power and a battery icon on the display shows the battery charge status.

4.2.1 – Power ON/OFF

SmartyCam 3 need to be powered by an external power source to be connected:

- to the front Binder female connector for **SmartyCam 3 Sport**
- to the 22 pins Deutsch male connector harness proper wires for **SmartyCam 3 Dual**
- to the 7 pins Binder female connector for **SmartyCam 3 GP**
- to the 5 pins Deutsch male connector (blue key) labelled "EXP" for **SmartyCam 3 GP Pro**
- to the 5 pins Binder 712 female connector labelled "EXP" for **SmartyCam 3 Corsa**

SmartyCam 3 powers ON when:

- the proper pushbutton is pushed
- an external power turns ON

SmartyCam 3 turns **automatically** OFF when power input is missing and the camera is idle for the time period set in: "MENU >> SETTINGS >> AUTO POWER OFF".

Available options are:

- 1 min
- 5 min (Default)
- 15 min
- 30 min

The camera is considered idle when:

- it is NOT recording
- there is NO active USB connection
- NO button is pressed
- SD card is not being inserted/extracted

Any change to the above conditions cancels or restarts the countdown for auto-power-off. If power input is restored the camera will NOT complete auto-power off procedure.

To **manually** power off SmartyCam 3 press the related button (🔌). The camera asks for confirmation.

Please note:

- **Although SmartyCam 3 Dual, SmartyCam 3 GP, SmartyCam 3 GP Pro and SmartyCam Corsa feature an USB-C connector in the (Micro) SD slot this USB-C connector CANNOT BE USED TO POWER THE CAMERA.**
- If **SmartyCam 3 Sport** is powered a steady red light is shown when the flap of the Micro SD card is open.

4.2.2 – Battery Status

SmartyCam 3 display shows the battery status with the following icons:



external power unavailable and battery is nearly at full capacity



external power unavailable and battery is approximately half of its charge



external power unavailable and battery has little charge available



external power available and battery is fully charged



external power available and battery is being charged

4.3 – LEDs working mode (all SmartyCam 3 except for SmartyCam 3 Sport)

SmartyCam 3 Dual features three front LEDs while SmartyCam 3 GP, SmartyCam 3 GP Pro and SmartyCam 3 Corsa feature one only LED in the SD Card slot. The following paragraphs explain how they work.

4.3.1 – Working Mode of SmartyCam 3 Dual front LEDs

SmartyCam 3 Dual features three front LEDs labelled as follows:

- PWR/CHN (Power/Charge) on top
- DATA central
- STATUS bottom

Their appearance changes according to the message they are giving



PWR/CHG LED

- **Off:** external power not available
- **Blinking Red:** external power available and battery charging
- **Solid Red:** external power available and battery fully charged

DATA

This LED indicates the status of the connection of the two available CAN busses (CAN1 and CAN2) as follows:

- **OFF:** no data traffic, no Ethernet connection and no USB connection detected
- **Blinking Green:** non data traffic but ethernet connection detected
- **Blinking Blue:** non data traffic detected but USB connection
- **Blinking Cyan:** non data traffic detected but ethernet and USB connection detected
- **Solid Green:** data traffic available on CAN1 but not available on CAN2
- **Solid Blue:** data traffic available on CAN2 but not available on CAN1
- **Solid Cyan:** data traffic available on both CAN1 and CAN2
- **Solid Red:** mandatory data traffic is missing on either CAN1 or CAN2 interface: the failure status is determined by the current camera configuration

Please note: timeout condition on both CAN bus interface triggers after no data is continuously detected for 5 seconds

STATUS

- **Solid Red:** camera powered but unable to record data
- **Solid Blue:** camera ready to start recording
- **Solid Green:** camera currently recording

4.3.2 – Working Mode of SmartyCam 3 GP, SmartyCam 3 GP Pro and SmartyCam 3 Corsa LED

SmartyCam 3 GP and
SmartyCam 3 GP Pro



SmartyCam 3 Corsa



SmartyCam 3 GP, SmartyCam GP Pro and SmartyCam 3 Corsa feature a LED in the SD Card slot whose appearance change according to the message they are giving.

- **OFF:** no external power detected, no USB traffic detected, no CAN EXP traffic detected, no ECU CAN traffic detected
- **Flashing:** external power detected and internal battery charging
- **Solid:** external power detected and internal battery fully charged

- **Flashing:** USB traffic detected
- **Solid:** CAN ECU traffic detected

Please Note: CAN ECU takes precedence on the reporting of USB connection. When CAN ECU traffic is detected USB Connection status will not be reported anymore until a Power off/Power on cycle has been completed.

- **Solid:** CAN EXP Traffic detected

5 – (Micro) SD card management

SmartyCam 3 cameras can support up to 2 TB cards. **SmartyCam 3 Sport** supports Micro SD only while **SmartyCam 3 Dual**, **SmartyCam 3 GP**, **SmartyCam 3 GP Pro** and **SmartyCam 3 Corsa** support SD. **For the (Micro) SD to correctly communicate with Race Studio 3 software you need to insert the card in SmartyCam 3 slot before inserting it in the PC slot.** The (Micro) SD is used not only to store video recorded by the camera but also to load the configuration and the firmware to the camera (see paragraph 7.4 for further information).

For both cameras the housing is closed by a plastic thumb screw. To open it press and turn the plastic thumb screw clockwise as written on the camera and shown here below. To close the door, firmly shut the flap and press in the thumbscrew then turn it counter clockwise.

SmartyCam 3 Sport



SmartyCam 3 Dual



SmartyCam 3 GP and SmartyCam 3 GP Pro



6 – SmartyCam 3 Start/Stop recording

SmartyCam 3 can start/stop recording manually or automatically.

When SmartyCam 3 is recording the display becomes red and switches off after a minute.

To **Manually Start Recording**, simply press "Rec" button. If you press it again, SmartyCam 3 stops recording

Automatically Start Recording:

It is possible to enable the Automatic Start Recording, following this path:

- "MENU →SETTINGS →AUTO START REC →". In this case SmartyCam 3 starts and stops recording without any activity by the user. There are two different ways for managing this setting:
 - SmartyCam 3 is **connected to a Master**: it starts recording the video when the master starts recording data.
 - SmartyCam 3 is **in a Stand Alone Installation**: you may define the conditions for starting and stopping the videorecording. This requires configuring SmartyCam 3 parameters through the Configuration software Race Studio 3, as explained in paragraph 8.1.3.

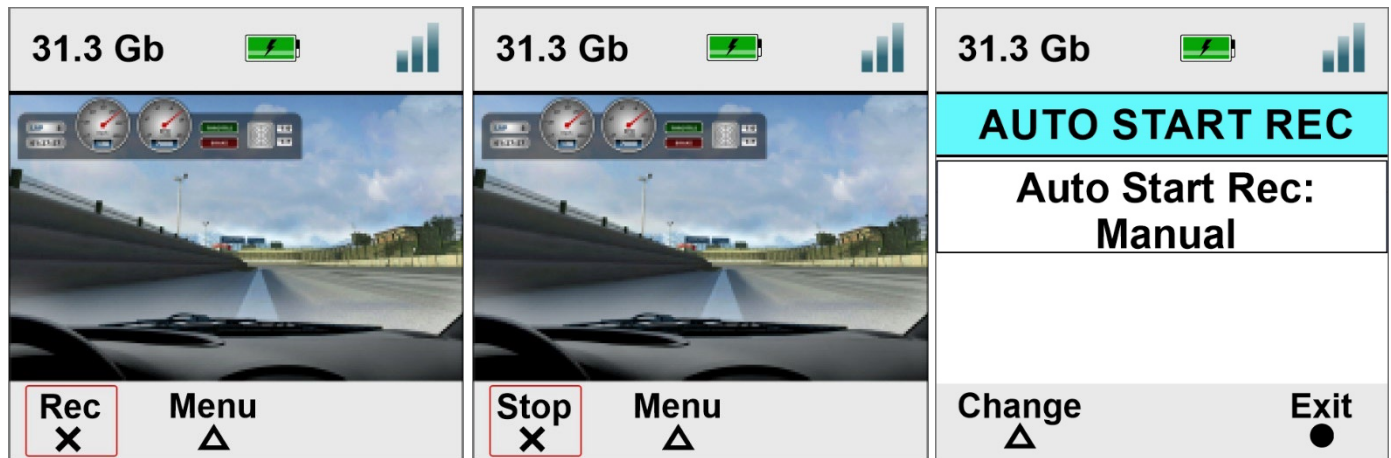

To set automatic stop recording follow this path: "MENU →SETTINGS →AUTO STOP REC"

Available options are:

- "5 sec"
- "20 sec" (default)
- "1 min"
- "2 min"
- "5 min"

The camera stops recording after the time period of inactivity here set.

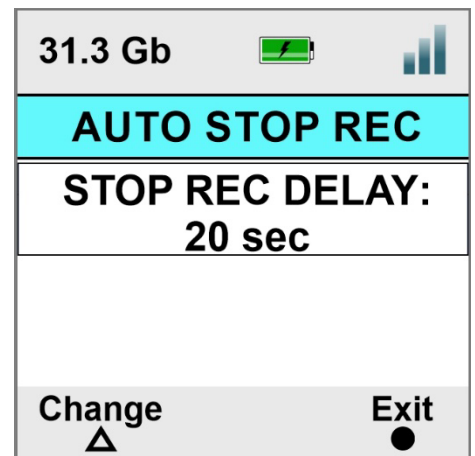

7 – SmartyCam 3 Menu

SmartyCam 3 settings can be changed using the pushbuttons. Pressing “MENU” this page shows up:

Available options are:

- **GPS STATUS:** status of the connected GPS
- **TRACKS:** to show the list
- **SETTINGS**
- **UPDATE**
- **VIDEO FILE**

In any situation use:

- “Down” (X) button to scroll the options
- “Sel” (Δ) to select and
- “Exit” (●) to quit and save

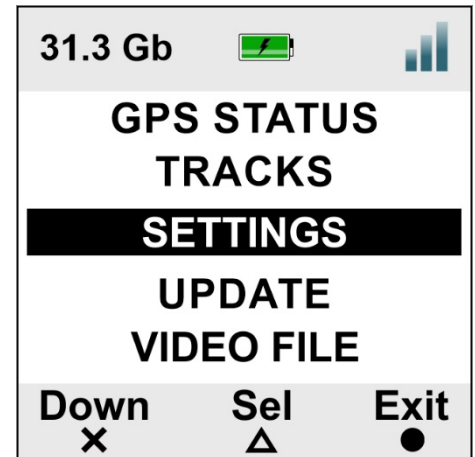

7.1 – GPS Status

Shows the number of connected satellites with the related signal level.

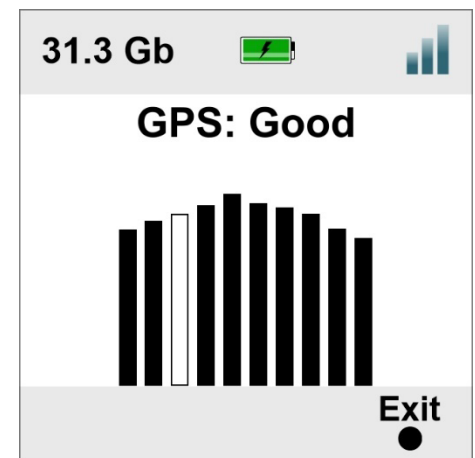

7.2 – Tracks

SmartyCam 3 can show the map of the circuit if loaded in its configuration (see paragraph 8.1.2 for further information) as well as the position of the vehicle on the track.



SmartyCam 3 can be installed in two ways:

- connected to an AiM logger such as : MyChron5, Solo 2 DL, MX* loggers, SW4, PDMs and EVOs; in this case the maps are loaded on AiM logger, that automatically selects the one you are racing on and transmits it to SmartyCam 3 that shows it in the video, in the position you defined during the configuration (please refer to paragraph 8.1.2 for further information).
- Connected to a GPS Module; in this last case you need to load the track maps directly to SmartyCam 3 using
 - the (Micro) SD (all versions; see paragraph 7.2.1 for further information)
 - the Ethernet cable (**SmartyCam 3 Dual only**)
 - the USB cable (**SmartyCam 3 GP, SmartyCam 3 GP Pro and SmartyCam 3 Corsa only**)

At the very first power ON the camera has no tracks in its internal database (image below) while if connected to an AiM Logger, this last will send the tracks information to the camera, else you need to load the tracks, as explained here down.

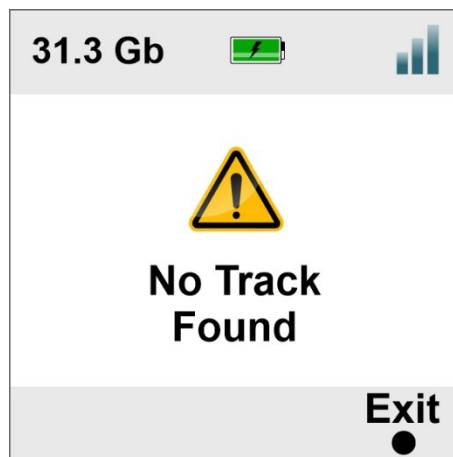

7.2.1 – Loading tracks to SmartyCam 3

Tracks can be loaded to SmartyCam3 through the (Micro)SD (standard procedure), through the ethernet or the USB connection according to the model you are using.

All cameras allow you to load tracks on SmartyCam 3 using the (Micro) SD card this way:

- place the (Micro) SD in SmartyCam3 and power it on – to properly format the card
- remove the card from SmartyCam and insert it in the PC slot
- run Race Studio3 software and load the tracks on the (Micro) SD (refer to paragraph 8.3 for further information)
- insert the (Micro) SD in SmartyCam 3 and follow this path: MENU → UPDATE → TRACKS
- press “Sel
- in a few seconds SmartyCam 3 loads the tracks.

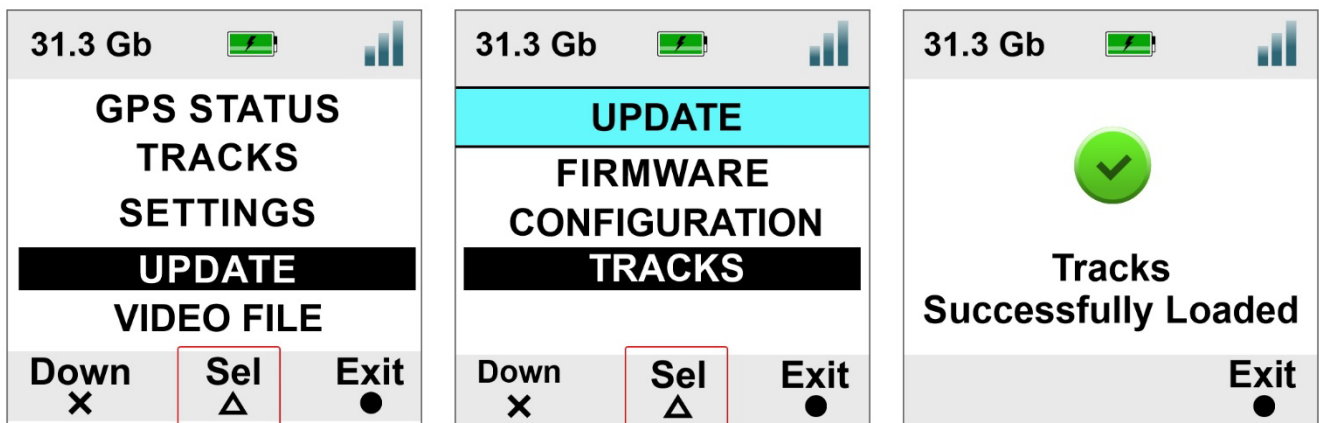

SmartyCam 3 Dual allows the user to **load the track** also **using** both **the Ethernet cable** included in standard+Ethernet and in Full harnesses or any USB-C cable; please perform these operations:

- with SmartyCam 3 Dual switched on and connected to the PC run Race Studio 3 software
- click “Track” Icon
- click on the SmartyCam 3 Dual you see bottom left of the software view
- select the tracks you want to load in the central column of the software view and drag and drop them to the right column where the tracks stored in SmartyCam are shown. Please refer to paragraph 8.3 for further information

SmartyCam 3 Dual, SmartyCam 3 GP, SmartyCam 3 GP Pro and SmartyCam 3 Corsa allows the user to **load the track also using any USB-C cable**; please perform these operations:

- with SmartyCam switched on and connected to the PC run Race Studio 3 software
- click “Track” Icon
- click on the SmartyCam you see bottom left of the software view
- in the central column of the software view select the tracks you want to load and drag and drop them to the right column where the tracks stored in SmartyCam are shown. Please refer to paragraph 8.3 for further information

7.2.2 – Managing tracks on SmartyCam 3

If **SmartyCam 3** is connected to **AiM GPS09 Module** only, track selection can be managed in two ways: automatic (AUTO – default) and manual

In **AUTO** mode SmartyCam 3 recognizes and selects the map of the circuit you are racing on.

In **MANUAL** mode you need to select the track by yourself. To **manually set a track** on SmartyCam 3:

- press “Change” (Default setting is Auto)
- the track list is shown: locate your track
- press: “View”
- press “Sel”
- SmartyCam 3 shows a confirmation message

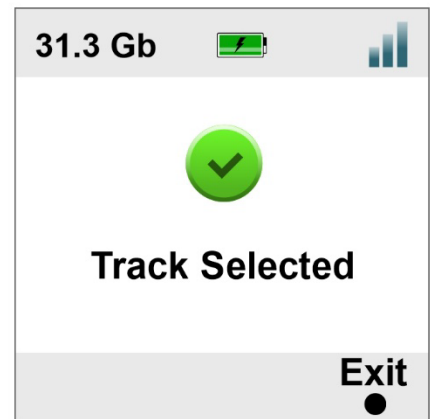
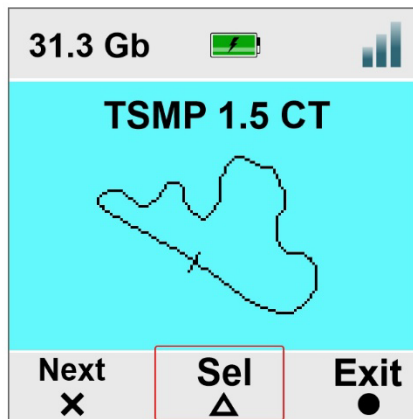
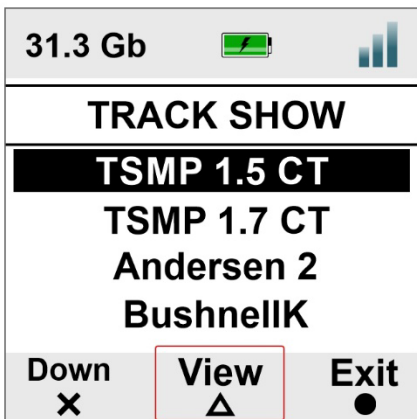

TRACKS Menu allows to **see a preview of the track** and the related information too. In “TRACK” menu scroll to “TRACK SHOW” and press “SEL”. This is very useful in case more configurations of the same tracks are available as shown here below.

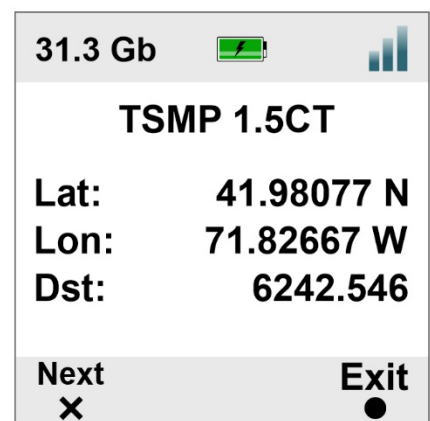
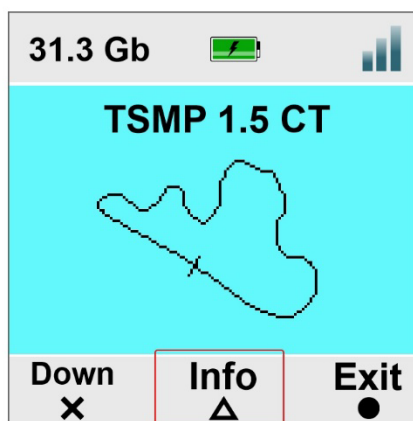
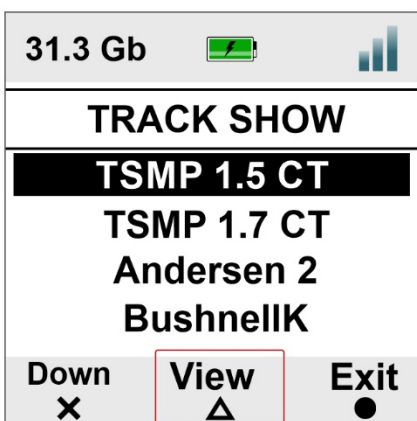



7.3 – Settings

Setting Menu is used to set:

- Auto Start Rec
- Auto Stop Rec
- Auto power off
- Key settings (**SmartyCam 3 Dual and SmartyCam GP only**)
- System Time
- Video set
- Exposure set
- Audio Set
- Video Output (**SmartyCam 3 Dual and SmartyCam 3 GP/GP Pro only**)
- Export Logs
- Export Conf
- Clear Tracks
- Factory Reset
- Rec Counter
- Overlay
- Flip over (**SmartyCam 3 Sport and SmartyCam 3 Corsa only**)
- Info

7.3.1 – Auto Start Rec

As explained in chapter 6, SmartyCam 3 is enabled for automatically start and stop the video recording. This happens in two different ways:

- if connected to an AiM Logger it starts/stops recording when the logger does
- if connected to a GPS09 Module it starts recording according to the conditions set in its configuration. Please refer to paragraph 8.1.3 for further information.

7.3.2 – Auto Stop Rec

As explained in chapter 6, Auto stop recording feature sets a delay that the SmartyCam 3 respects before closing the mp4 file when the recording conditions are no longer met.

7.3.3 – Auto power off

As explained in paragraph 4.2, SmartyCam 3 turns automatically OFF after a time period, here defined, of no activity detected.

7.3.4 – Key settings (SmartyCam 3 Dual and SmartyCam 3 GP only)

Key settings option allows the user to disable SmartyCam 3 pushbuttons when the vehicle is moving. Default setting is “NO”: push “Change” to switch to “YES”.

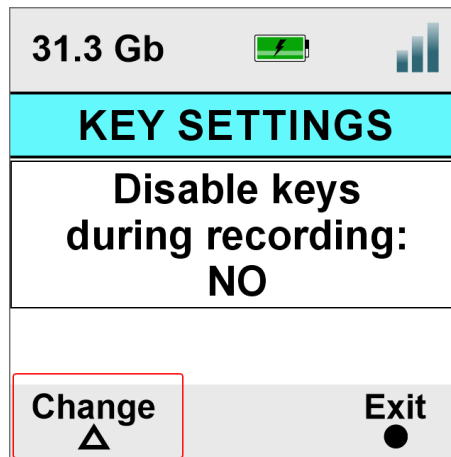

7.3.5 – System time

SmartyCam 3 has an internal clock powered by a battery and constantly updated by the external GPS09 Module. **Please note** that both Time Zone and Saving Time Zone are considered and automatically corrected. In this Menu Voice you may define different date/time formats.

- Available time formats are: 0-11.59 am/pm or 1-12.59 am/pm or 0-24
- Available date format are: DD/MM/YYYY or MM/DD/YYYY or YYYY/MM/DD

7.3.6 – Video Set (SmartyCam 3 GP only)

This option allows to set the frame rate. Available options are:

- 30fps (Default)
- 60 fps (please be careful when touching the camera set at 60fps because it can be very hot)

7.3.7 – Exposure set

This option allows to set the part of the shot to be used as reference. As shown in the images below:

- use “Change” button to modify the area to be used for adjusting the light. The area is shown through a red rectangle. Please, select the whole frame (right image below) in case of installations in open cockpits.
- use “Exit” button to save and exit

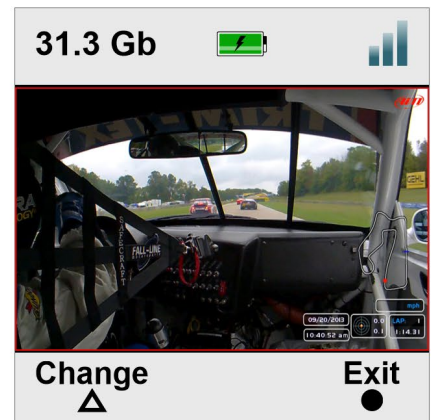
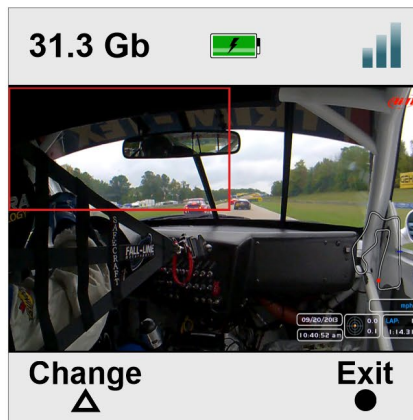
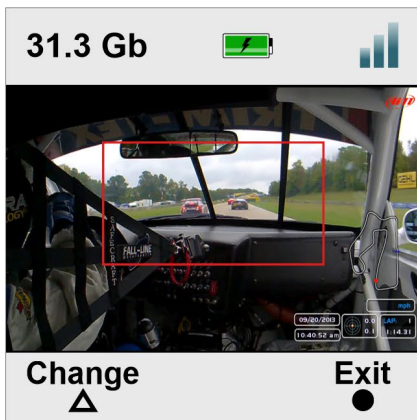

SmartyCam 3 Dual only has two bullet cameras: you may select the one for which you like to set the exposure.

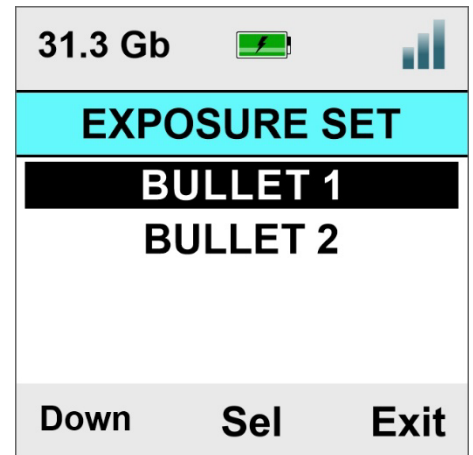

7.3.8 – Audio set

SmartyCam 3 comes with an internal microphone. To set it.

- Use “Change” button to set the gain
- Use “Exit” button to save and exit

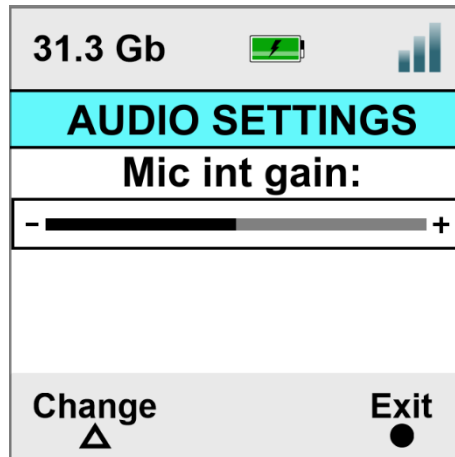

SmartyCam 3 Dual, **SmartyCam 3 GP** and **SmartyCam 3 Corsa** support an external microphone too as shown here below. To connect it you need:

- **SmartyCam 3 Dual** full harness that can support any microphone that features a 3.5mm jack male connector
- one among these available optional cables for **SmartyCam 3 GP** and **SmartyCam 3 Corsa**, to say:
 - cable with jack for external microphone (part number **V02584040**) that can support any microphone that features a 3.5mm jack male connector
 - cable with CAN ECU and jack for external microphone (part number **V02584140**) that can support any microphone that features a 3.5mm jack male connector

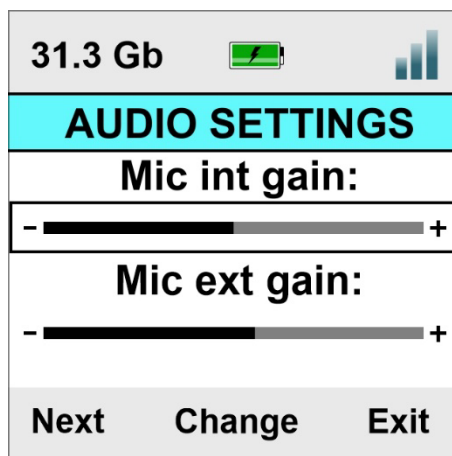

7.3.9 – Video Out (SmartyCam 3 Dual and SmartyCam 3 GP only)

SmartyCam 3 Dual, SmartyCam 3 GP and SmartyCam 3 GP Pro feature an SDI video output that allows to send the video/audio stream to a streamer. Available options are:

- disable (default)
- 1080@60 (this setting can lead to high temperature risk)
- 1080@50
- 1080@30
- 1080@25

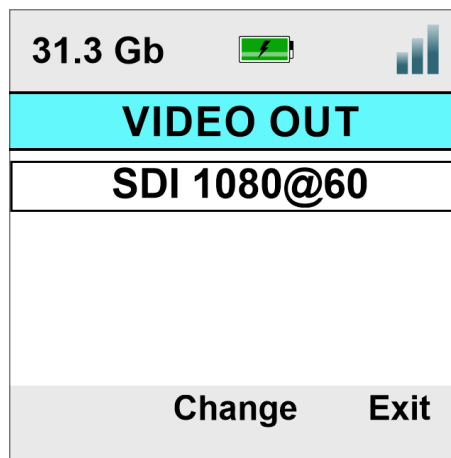

7.3.10 – Export LOGS

When SmartyCam3 is on it creates a LOG FILE containing all the information that can help understanding possible problems. This file records all information from the switch on and keeps about a month time memory. In case you need help from AiM Support team, please, export the LOG file to the (Micro) SD and send it to our support team. **Please note:** logs file can only be exported to the (Micro) SD.

7.3.11 – Export Conf (SmartyCam 3 GP and SmartyCam 3 Dual only)

This option allows to export the current SmartyCam configuration to the SD card. A time bar is shown and the configuration is exported.

7.3.12 – Clear tracks

Here you can clear all tracks from SmartyCam3; the system asks for confirmation.

7.3.13 – Factory reset

This menu option resets SmartyCam 3 to its default values, shown in the fourth page of Info function (Paragraph 7.3.17).

7.3.14 – Rec Counter

This page shows the number of recording of SmartyCam 3. Press "Reset" to reset the counter.

7.3.15 – Overlay

In case you wish to record a video without Overlays, you may disable them in this voice of the menu.

7.3.16 – Flip over (SmartyCam 3 Sport and SmartyCam 3 Corsa only)

SmartyCam 3 Sport and **SmartyCam 3 Corsa** have a standard ¼ thread in its base that is used for mounting it. Sometimes, in closed cars, it is more comfortable to install the camera upside down. In this case, you have to flip the video over.



7.3.17 – Info

The information here shown are important in case you need help from AiM Support Team. “Restore Info” page tells you which firmware release will be restored if you decide to perform a factory reset.

Please note: for SmartyCam 3 GP and SmartyCam 3 Dual only one/two page(s) concerning the bullet is/are available.

<p>31.3 Gb </p> <p>SYSTEM INFO</p> <p>Fw-Rel:01.13.11 Fw-Date: 19/07/2024 Fw-Hour: 12.26 SN: 4117064</p> <p>Next Exit </p>	<p>31.3 Gb </p> <p>CONNECTION INFO</p> <p>AiM-SC3 - 4117064</p> <p>Next Exit </p>	<p>31.3 Gb </p> <p>HW INFO</p> <p>Smarty3_GP Hw Rel: SMC11C Date: 2024-07-29</p> <p>Next Exit </p>
<p>31.3 Gb </p> <p>BULLET 0</p> <p>Cmos: ar0234</p> <p>Next Exit </p>	<p>31.3 Gb </p> <p>RESTORE INFO</p> <p>Rel: 01.07.02 Date: 19/07/2024 Hour: 12.26</p> <p>Next Exit </p>	<p>31.3 Gb </p> <p>SLAVE INFO</p> <p>GPS 09C Fw-Rel: 02.42.08 SN: 8713141</p> <p>Next Exit </p>

7.4 – Update

It allows to update:

- SmartyCam 3 Firmware
- Configuration (the overlay transmitted to SmartyCam3); the camera can load one configuration at a time only}
- Tracks

Updating can be performed in three ways:

- exporting firmware, configuration or tracks to the (Micro) SD through AiM RaceStudio 3 software and loading them to SmartyCam 3
- through the USB-C connection (**except for SmartyCam 3 Sport**)
- through the Ethernet connection (**SmartyCam 3 Dual only**).

31.3 Gb

UPDATE

FIRMWARE

CONFIGURATION

TRACKS

Down Sel Exit

7.4.1 – Firmup

All SmartyCam 3 can update the firmware through the (Micro) SD following this procedure:

- insert the (Micro) SD in SmartyCam 3 slot and switch the camera on so that Race Studio 3 will correctly communicate with it
- remove the card from SmartyCam 3 and insert it in the PC Slot
- run Race Studio 3 and navigate to the top right “web updates” cloud icon
- if a new SmartyCam 3 firmware is available check mark it and click “download”
- the software detects SmartyCam 3 (Micro) SD and – as you click “update device” – loads the firmware on it
- replace the (Micro) SD in SmartyCam 3 slot and switch the camera on
- follow this path MENU >> FIRMUP
- the camera shows the available firmware releases
- select the one you want to install and wait; in a few moments the camera will reboot and the new firmware is installed.

SmartyCam 3 Dual can update the firmware **also through the Ethernet connection**: connect the camera to the PC using the proper cable:

- run Race Studio 3 and navigate to the top right “web updates” cloud icon
- If there is a new SmartyCam 3 firmware check mark it and click “download”
- once the firmware downloaded click “update device” and wait; in a few moments the camera will reboot and be updated.

SmartyCam 3 Dual, SmartyCam 3 GP, SmartyCam 3 GP Pro and SmartyCam 3 Corsa can update the **firmware also through the USB-C connection** placed in the camera Micro (SD) slot: connect SmartyCam 3 to the PC using the proper cable:

- run Race Studio 3 and navigate to the top right “web updates” cloud icon
- If there is a new SmartyCam 3 firmware check mark it and click “download”
- once the firmware downloaded click “update device” and wait; in a few moments the camera will reboot and be updated.

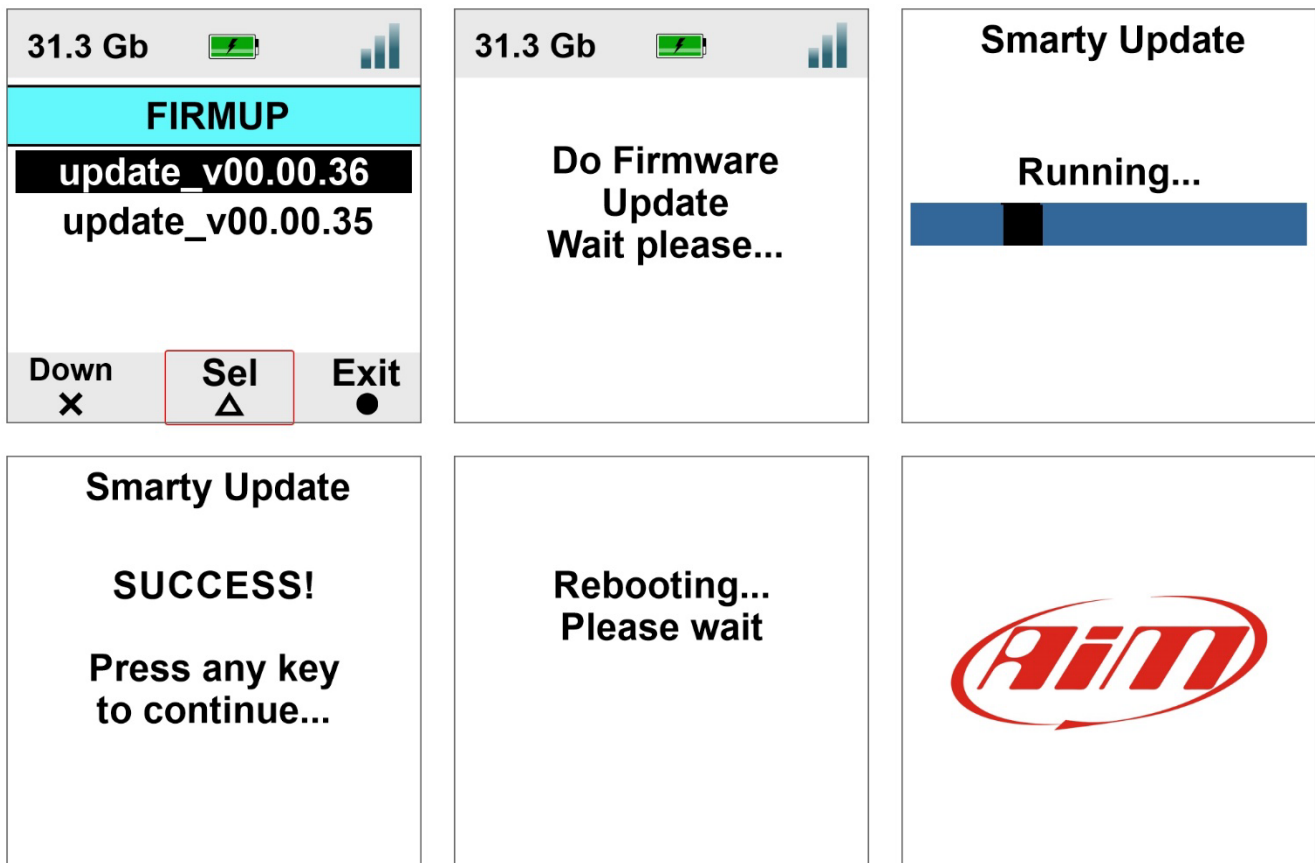

7.4.2 – Tracks update

Tracks can be updated as the firmware does. Please refer to paragraph 7.4.

7.5 – Video file

This page shows the list of video file stored in SmartyCam 3 (Micro) SD card.

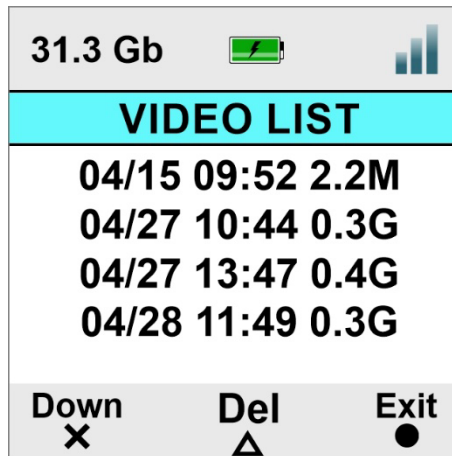

SmartyCam 3 GP Pro features an additional 64 Gb internal memory too; entering “Video File” function the system asks the user to select the storage device to manage.

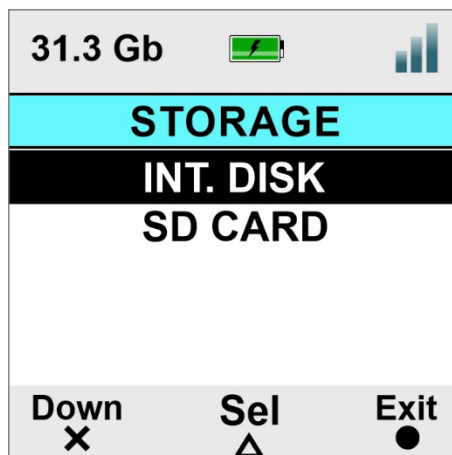

8 – SmartyCam 3 and the PC

As for Firmware Updating, Tracks and Configuration Loading SmartyCam 3 can be configured using the (Micro) SD but, in addition to this mode, SmartyCam 3 Dual can be configured also connecting it directly to the PC through Ethernet or USB – C connection.

8.1 – Creating SmartyCam 3 configuration

To create SmartyCam 3 configuration:

- Run Race Studio 3 software
- press “NEW” to create a new configuration
- “Choose new device” panel appears (1)
- scroll it and select your “SmartyCam 3” (3) or type the name of the device you are to configure in the dedicated search box (2)
- fill in the panel that is prompted and press “OK”

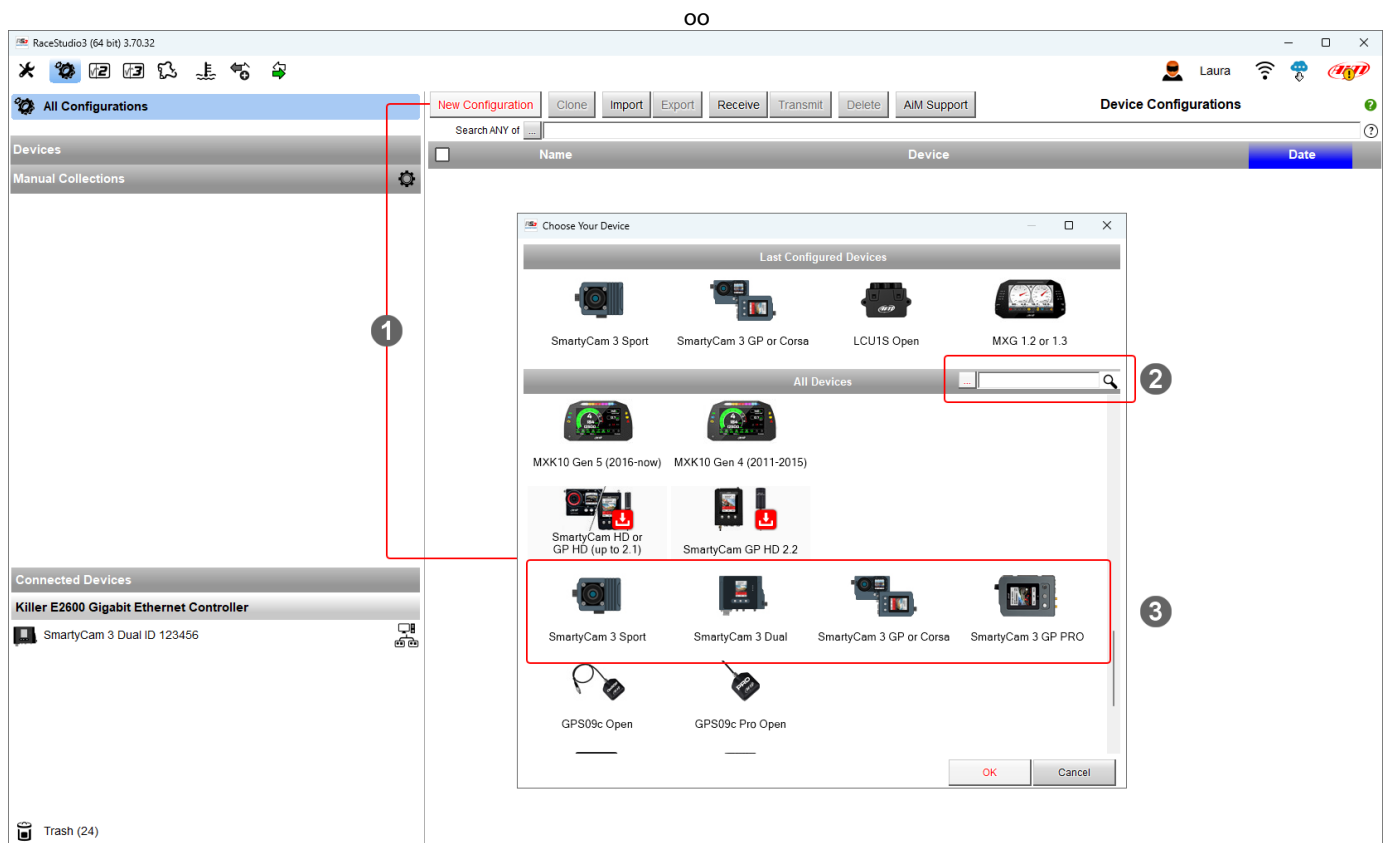

Race Studio 3 software enters directly SmartyCam 3 overlay tab. The tabs to configure change according to your camera model. SmartyCam 3 can be connected to a **MASTER** (any **AiM Logger**): in this case, it must be configured in **"SLAVE MODE"** and will receive all the information to be shown from the logger

Standalone: in this case it can be connected to:

- AiM GPS Module09cPro and GPS09c Pro Open only to show GPS data (position, speed, accelerations, Lap Number, Lap Time- **SmartyCam 3 all models**)
- AiM GPS Module09c GPS Module09c Pro and the vehicle ECU showing all data coming from both (**except for SmartyCam3 Sport that does not support ECU stream**)

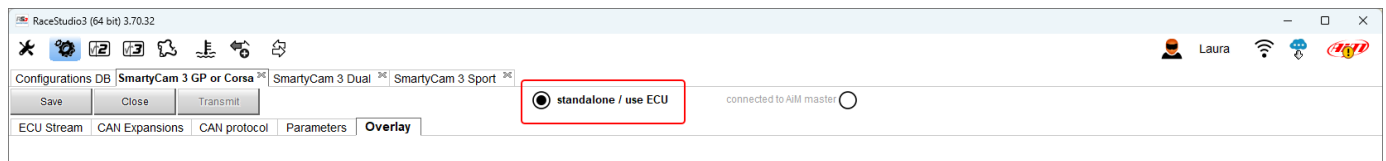

As said tabs to configure changes according to your SmartyCam 3 model but no matter which model is to be configured, if the camera is in **standalone mode "CAN protocol" functionality is not available, as highlighted below.**

Tabs to configure for **SmartyCam 3 Sport** standalone are:

- "CAN Expansions"
- "Parameters" and
- "Overlay" tab

Tabs to configure for **SmartyCam 3 Dual, SmartyCam 3 GP, SmartyCam 3 GP Pro or SmartyCam 3 Corsa** are:

- "ECU Stream"
- "CAN Expansions"
- "Parameters"
- "Overlay"

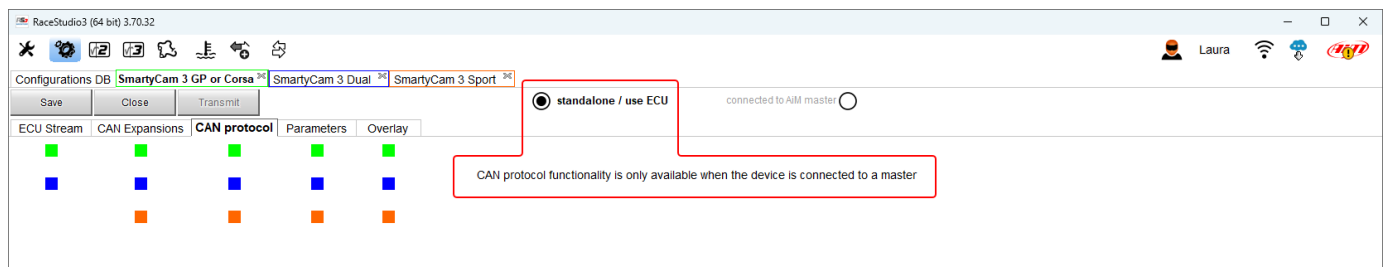

8.1.1 – Configuring SmartyCam 3 overlay

Overlay configuration tab changes according to your SmartyCam 3 setting.

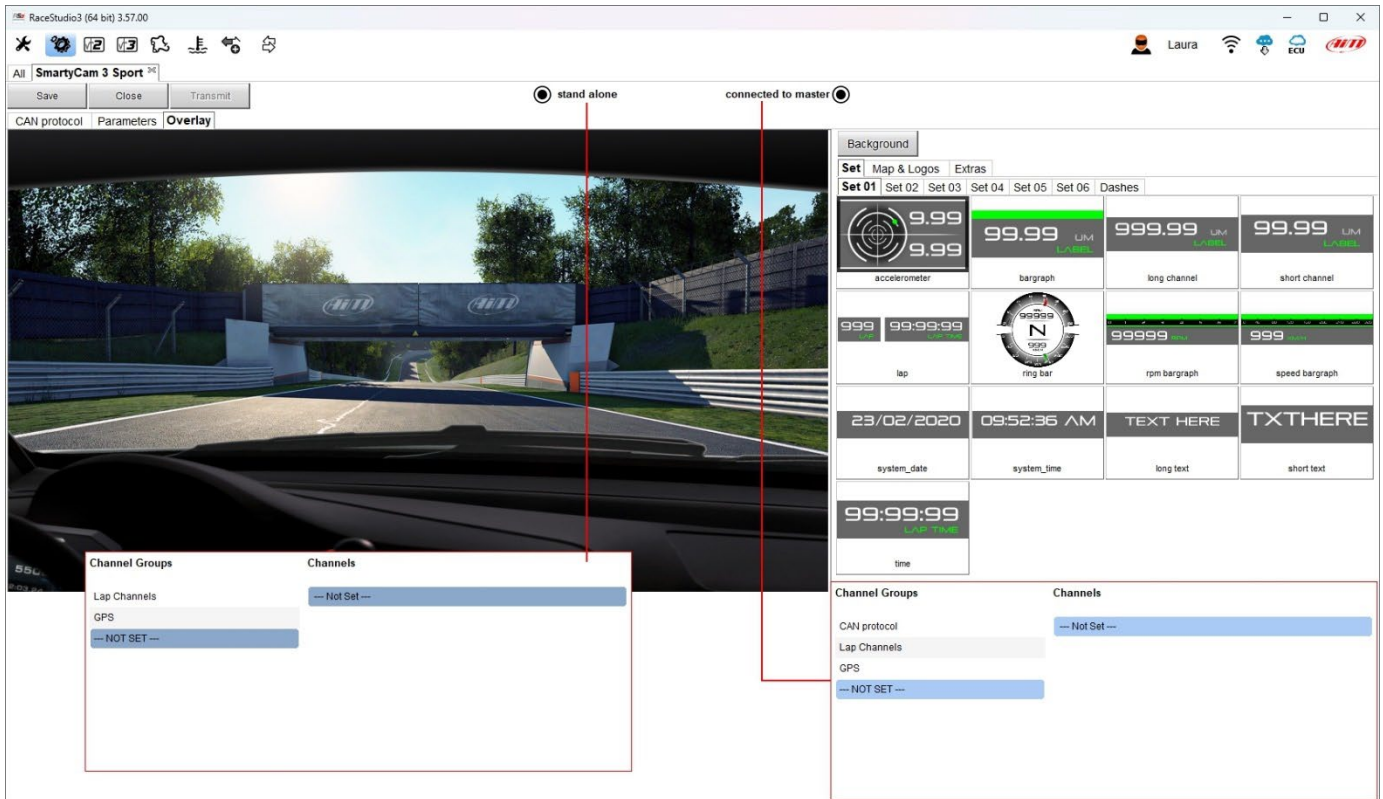

The overlays you may add to your video are:

- Graphical data
- Track Map and Logos
- Second Camera as **P in P** (picture in picture – **SmartyCam 3 Dual only**) as shown here on the right
- Extras:
 - generic graphic controls like coloured bar graph you can match to any channel
 - specific graphic controls that match specific channels indicated in the bottom left panel of the page when you drag and drop the control in the preview part of the page.

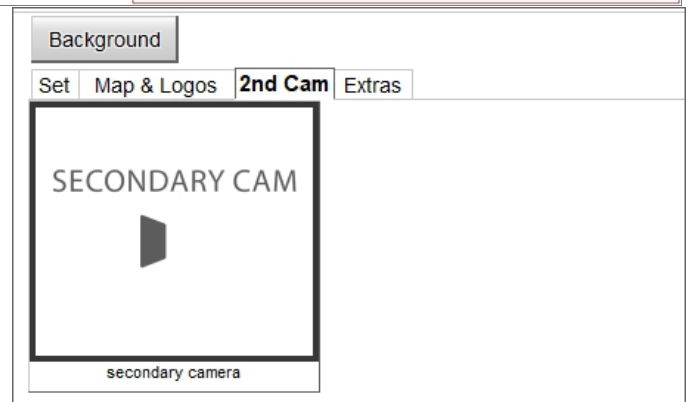



You may choose in a wide set of graphical controls double clicking on the one you prefer or dragging and dropping it to the desired position in the video preview.

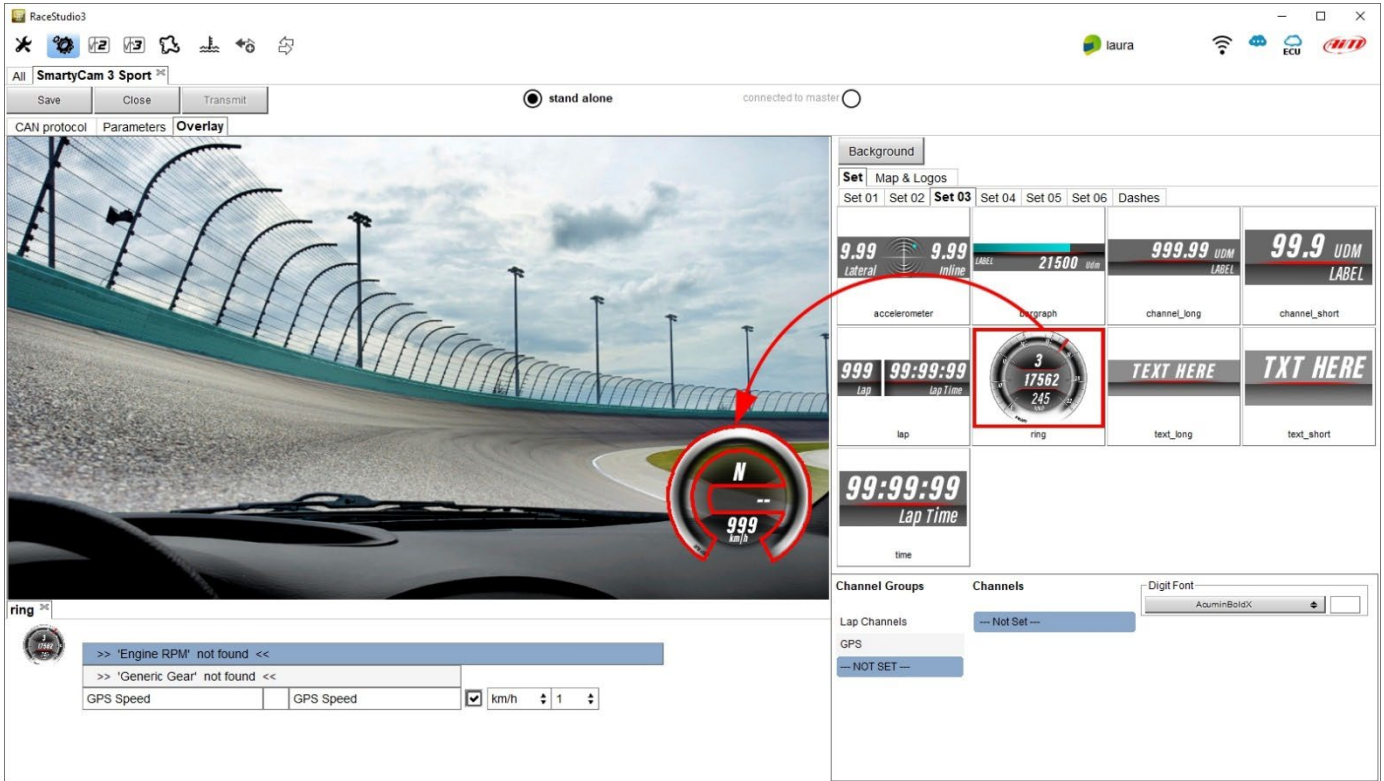

If a graphical control may show a range of possible information, you must select the appropriate channel. In the example below you are configuring a control that may show Lap Number, Lap Time, best Time, Predictive Time etc.: simply click on the desired information and you will set it.

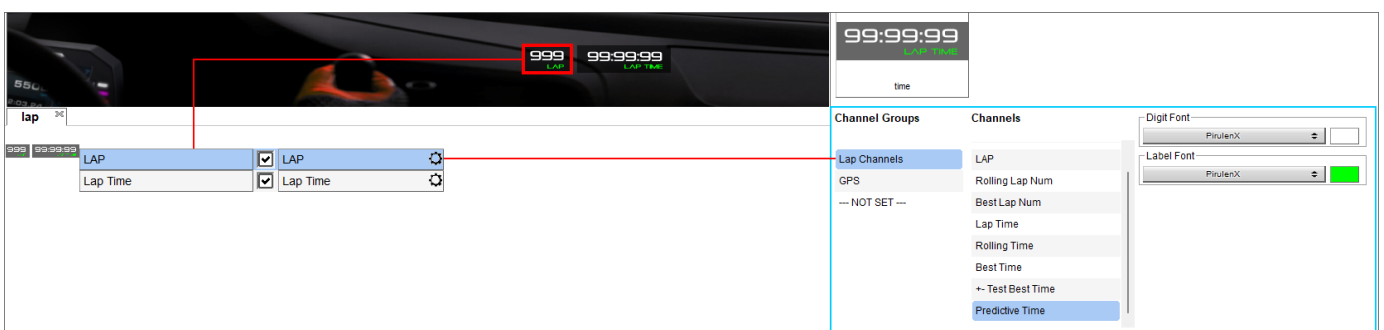

8.1.2 – Logos & MAP and second camera (SmartyCam 3 dual only) setting

To add the map of the circuit or a logo to the video please click on Maps & Logos and drop the logo or the Track Map in the desired position. You may easily change shape, dimension, and position or add a new logo.

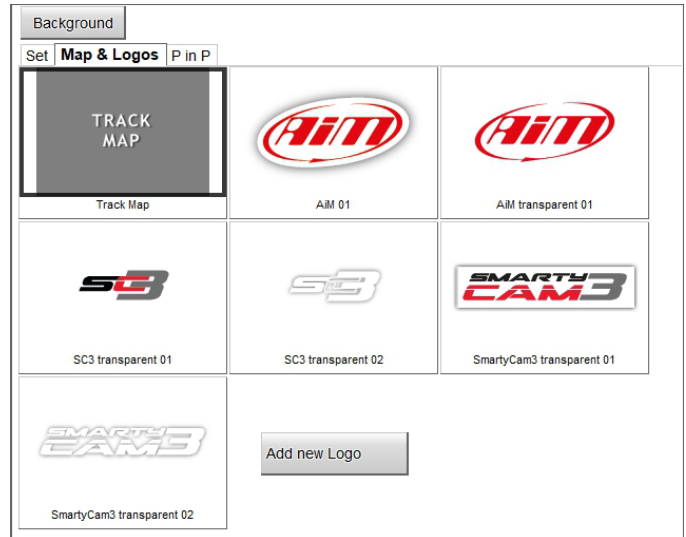

Please, note that, when configuring SmartyCam 3, you only set position and dimension of the track map while the shape of the circuit dynamically changes according to the circuit you are racing on.

Here on the right you see an overlay where both track map and secondary camera as Picture in picture (SmartyCam 3 dual only) are set.

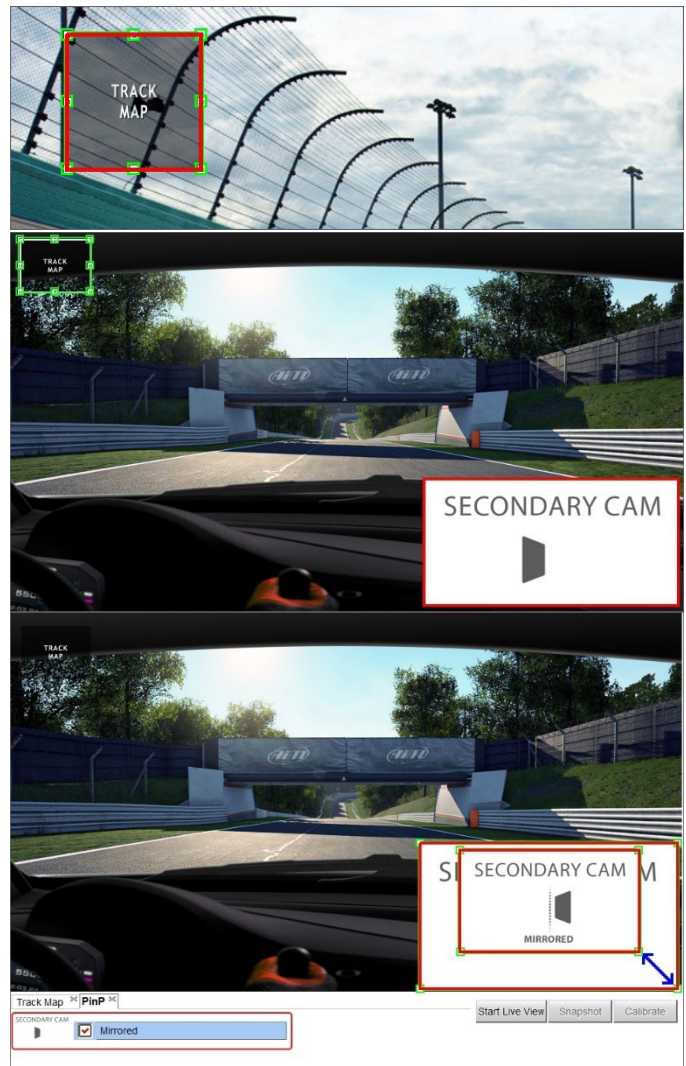

Starting from:

- SmartyCam Dual firmware version 1.03.05
- and Race Studio 3 software version 3.55.07

it is possible to resize and mirror the secondary camera as shown here on the right.

8.1.3 – Configuring SmartyCam 3 parameters for start recording

If SmartyCam 3 is **connected to a Master** it starts recording when the master does.

In case of a **Stand-Alone** installation SmartyCam3 start recording at different condition according to the model you are using. **SmartyCam 3 Sport** starts recording when speed is greater than 10kmh (if GPS is valid too) but you can set a custom condition.

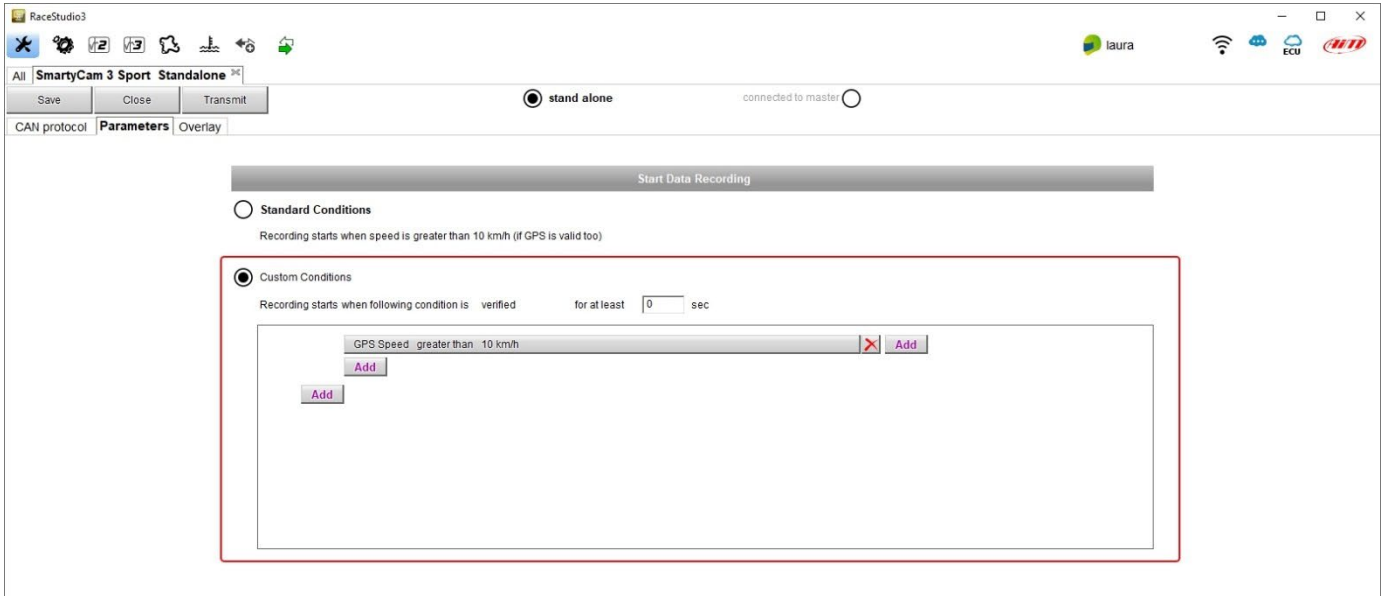

SmartyCam 3 Dual, SmartyCam 3GP, SmartyCam 3 GP Pro and SmartyCam 3 Corsa start recording when RPM (if available) is greater than 850 or speed is greater than 10kmh but you can set custom condition, using an ECU channel too as shown here below.

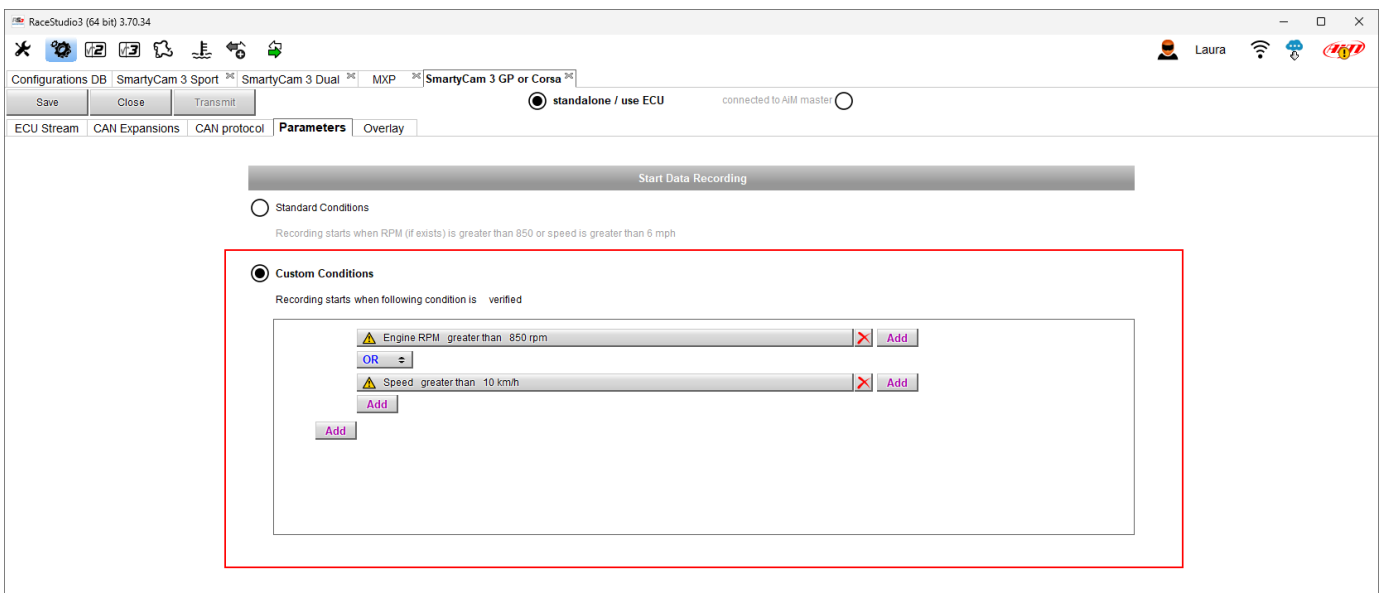

8.1.4 – Configuring CAN Protocol (SmartyCam 3 connected to a master only)

The connection between any AiM Logger and SmartyCam3 is made through the CAN bus. The logger transmits data to the camera in two slightly different ways:

- AiM default Protocol
- Advanced Protocol

AiM Default Protocol transmits a rather limited range of information, enough for a wide range of installations. They are shown below:

The screenshot shows the 'CAN protocol' configuration window in RaceStudio3. The window title is 'SmartyCam 3 Sport' and it is currently set to 'connected to master'. The protocol selected is 'AiM - AiM STREAM (ver. 02.00.04)'. There are 19 enabled channels listed in a table below.

ID	<input checked="" type="checkbox"/>	Name	Function	Unit	Freq
CC01	<input checked="" type="checkbox"/>	Engine RPM	Engine RPM	rpm	10 Hz
CC02	<input checked="" type="checkbox"/>	Speed	Vehicle Spd	km/h 0.1	10 Hz
CC03	<input checked="" type="checkbox"/>	Gear	Gear	gear	10 Hz
CC04	<input checked="" type="checkbox"/>	Water Temp	Water Temp	C 0.1	10 Hz
CC05	<input checked="" type="checkbox"/>	Head Temp	Head Temp	C 0.1	10 Hz
CC06	<input checked="" type="checkbox"/>	Exhaust Temp	Exhaust Temp	C 0.1	10 Hz
CC07	<input checked="" type="checkbox"/>	Oil Temp	Oil Temp	C 0.1	10 Hz
CC08	<input checked="" type="checkbox"/>	Oil Press	Oil Pressure	bar 0.01	10 Hz
CC09	<input checked="" type="checkbox"/>	Brake Press	Brake Press	bar 0.1	10 Hz
CC10	<input checked="" type="checkbox"/>	Throttle Pos	Pct Throttle Load	% 0.01	10 Hz
CC11	<input checked="" type="checkbox"/>	Brake Pos	Pct Brake Load	% 0.01	10 Hz
CC12	<input checked="" type="checkbox"/>	Clutch Pos	Percent	% 0.01	10 Hz
CC13	<input checked="" type="checkbox"/>	Steering Pos	Steering Pos	deg 0.1	10 Hz
CC14	<input checked="" type="checkbox"/>	Lambda	Lambda	lambda 0.01	10 Hz
CC15	<input checked="" type="checkbox"/>	Lateral Acc	Lateral Accel	g 0.01	10 Hz
CC16	<input checked="" type="checkbox"/>	Inline Acc	Inline Accel	g 0.01	10 Hz
CC17	<input checked="" type="checkbox"/>	Fuel Level	Pct Fuel Level	% 0.01	10 Hz
CC18	<input checked="" type="checkbox"/>	Battery Voltage	Voltage	mV	10 Hz
CC19	<input checked="" type="checkbox"/>	Vertical Acc	Vertical Accel	g 0.01	10 Hz

If you wish to transmit a different set of information, you may do as follows:

- Configure your Logger in order to transmit a different SmartyCam Stream
- Select the desired SmartyCam Stream in SmartyCam 3 configuration

Follow the steps shown in the following figures:

- while configuring AiM logger select “Advanced” option in SmartyCam Stream layer.

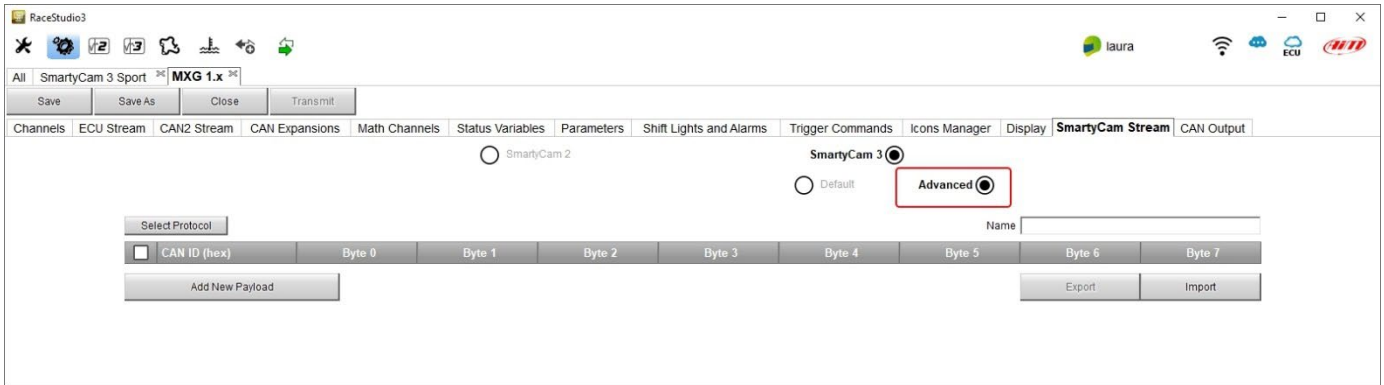

- Create your desired Stream, defining the required IDs and fields
- Name the protocol and save it

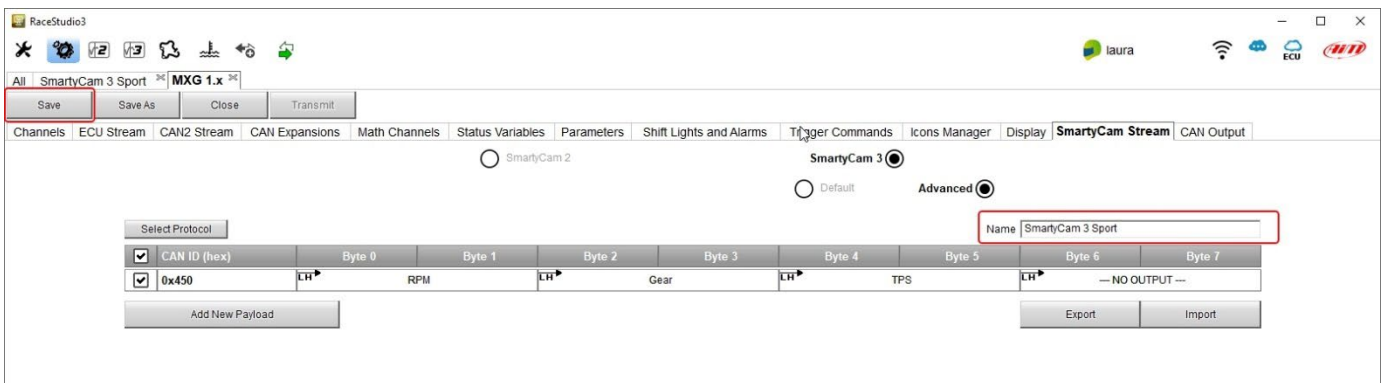

- Once the Logger configuration saved, you may import the protocol in SmartyCam 3 configuration and use the channels as required.

Please, note that ALL data transmitted to SmartyCam3 are stored as metadata directly in the .mp4 file in order to be analysed by RaceStudio3 Analysis

The screenshot shows the RaceStudio3 interface with the 'Select Protocol' dialog box open. The dialog box is titled 'Select AIM SmartyCam3 Stream Protocol' and contains a table with columns for 'Protocol name' and 'Configuration'. The 'Protocol name' is 'SmartyCam 3 Sport' and the 'Configuration' is 'MXG 1.x'. The background shows the 'Enabled Channels' list with 20 channels checked.

ID	Name	Unit	Resolution	Frequency
CC01	Engine RPM	rpm	1	10 Hz
CC02	Speed	km/h	1	10 Hz
CC03	Gear	gear	1	10 Hz
CC04	Water Temp	°C	0.1	10 Hz
CC05	Head Temp	°C	0.1	10 Hz
CC06	Exhaust Temp	°C	0.1	10 Hz
CC07	Oil Temp	°C	0.1	10 Hz
CC08	Oil Press	Oil Pressure	bar 0.01	10 Hz
CC09	Brake Press	Brake Press	bar 0.1	10 Hz
CC10	Throttle Pos	Pct Throttle Load	% 0.01	10 Hz
CC11	Brake Pos	Pct Brake Load	% 0.01	10 Hz
CC12	Clutch Pos	Percent	% 0.01	10 Hz
CC13	Steering Pos	Steering Pos	deg 0.1	10 Hz
CC14	Lambda	Lambda	lambda 0.01	10 Hz
CC15	Lateral Acc	Lateral Accel	g 0.01	10 Hz
CC16	Inline Acc	Inline Accel	g 0.01	10 Hz
CC17	Fuel Level	Pct Fuel Level	% 0.01	10 Hz
CC18	Battery Voltage	Voltage	mV	10 Hz
CC19	Vertical Acc	Vertical Accel	g 0.01	10 Hz
CC20	Logger Temp	Temperature	C 0.1	10 Hz

8.1.5 – ECU Stream (all SmartyCam 3 except for SmartyCam 3 Sport)

SmartyCam 3 Dual, SmartyCam3 GP, SmartyCam 3 GP Pro and SmartyCam 3 Corsa feature a second CAN protocol that allows the user to set the ECU Stream of a wide number of supported ECUs. At the very first configuration “ECU Stream” tab prompts the panel to set as shown here below. To change it in a second moment press “Change ECU” button and the panel will be prompted again.

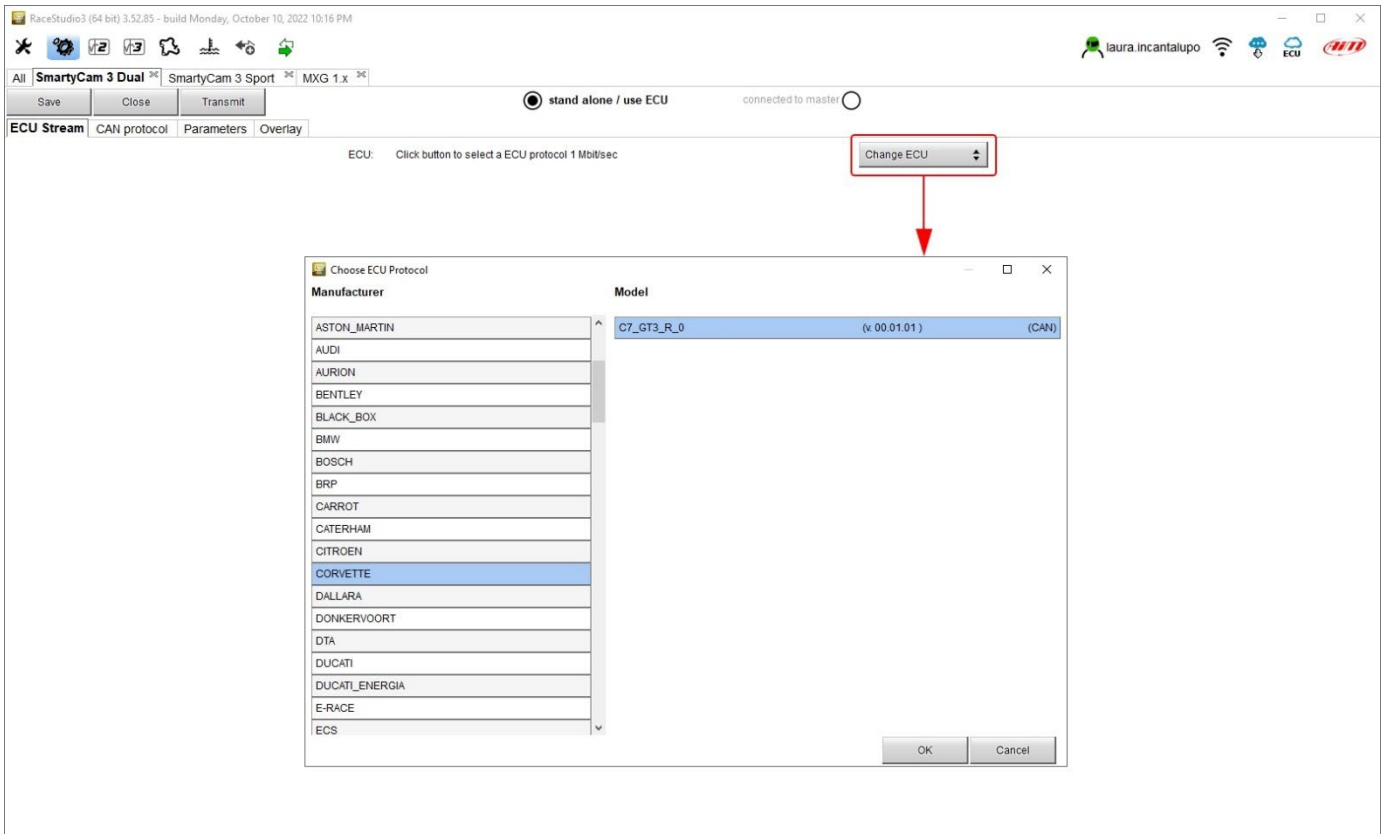

8.2 – Loading the configuration to SmartyCam 3

All cameras allow the transmission of the configuration through the (Micro) SD card. **SmartyCam 3 Dual, SmartyCam 3 GP, SmartyCam 3 GP Pro** and **SmartyCam 3 Corsa** allow the transmission of the configuration through the USB-C connection too. **SmartyCam 3 Dual** allows the transmission of the configuration through Ethernet/USB-C connection too.

Configuration transmission through (Micro) SD Card (SmartyCam 3 all models)

- Save the configuration pressing “Save” button top left of the page
- insert a (Micro) SD in SmartyCam3 slot
- remove the (Micro) SD from SmartyCam3 slot and insert it the PC slot
- press “Transmit” button; the software recognizes the (Micro) SD and loads the configuration
- remove the (Micro) SD from the PC slot and insert it in SmartyCam3 slot
- follow this path: “MENU” -> “UPDATE” -> “CONFIGURATION” and load the configuration to SmartyCam 3

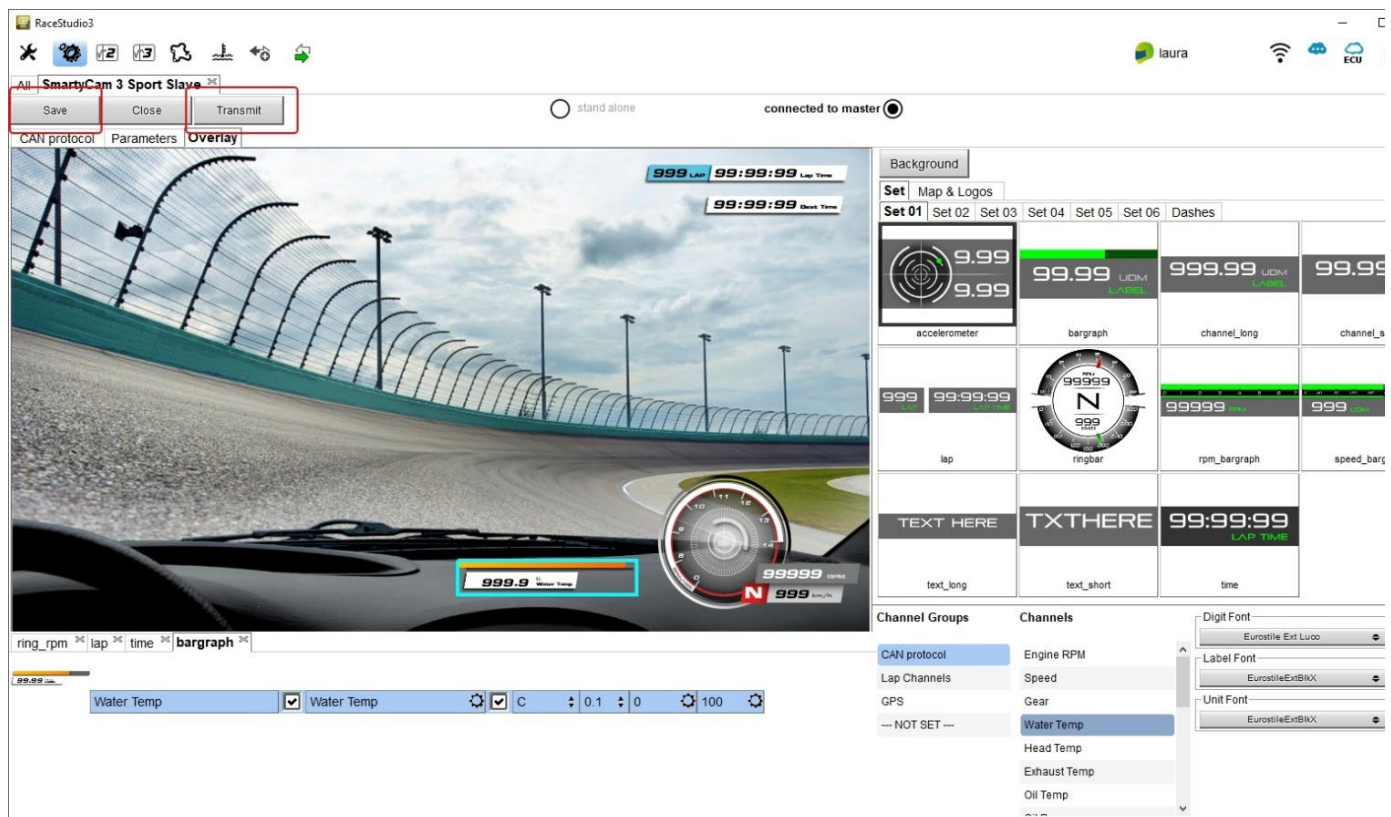

Configuration transmission through Ethernet or USB-C connection

SmartyCam 3 Dual, SmartyCam 3 GP, SmartyCam 3 GP Pro and **SmartyCam 3 Corsa** allow you to transmit the configuration to the camera using the USB-C connection while **SmartyCam 3 Dual** also allows transmission through the Ethernet connection. To do so, with the camera switched on and connected to the PC:

- Press “Save” top left on the software view
- Press “Transmit” and the camera will receive the configuration
- Follow this path on SmartyCam 3 Dual: “MENU” -> “UPDATE” -> “CONFIGURATION” and the configuration is loaded to SmartyCam 3.

8.3 – Track Management

Track Manager is the software section dedicated to tracks management. Here you can create and delete new tracks, modify the settings as well as load them to the Card or straight to SmartyCam 3 (except for SmartyCam 3 Sport). Press “Tracks” on Race Studio 3 top left keyboard.



The main page is divided in three columns: on the **Left**:

- on top the filters to collect the tracks; by default all tracks are shown – “All Tracks (5327)” in the image below. The filters are:
 - nations: select the nation you want to see the tracks of
 - smart collections: clicking the setting icon a panel that allows to select continent, nation, circuit type and road surface is prompted; select the criteria you wish and name the collection specifying the used filter if you like it
 - manual: clicking the setting icon a new collection panel is prompted: name it and drag and drop the tracks in it
- bottom the connected devices in the image SmartyCam 3 Sport “SmartyCam 3 ID 4111112 [TEST-2 – D:]”

The column **in the middle** shows:

- on top a fast search bar, that allows to select the tracks which satisfy personal research criteria; pressing “?” a tooltip explains the research criteria (highlighted in red below); to say:
 - track long name contains.....: long name is the name in bold in each track box
 - track short name contains....: short name is the track name shown top right of each track box
 - track city begins with....: is the name of the city the track is located in
- all the tracks listed in Race Studio 3 database. You can update your track database at start up if a connection to the Internet is available.

The column on the **Right** shows two tabs:

- the data sheet of the track you are mousing over and
- its weather forecast if available.

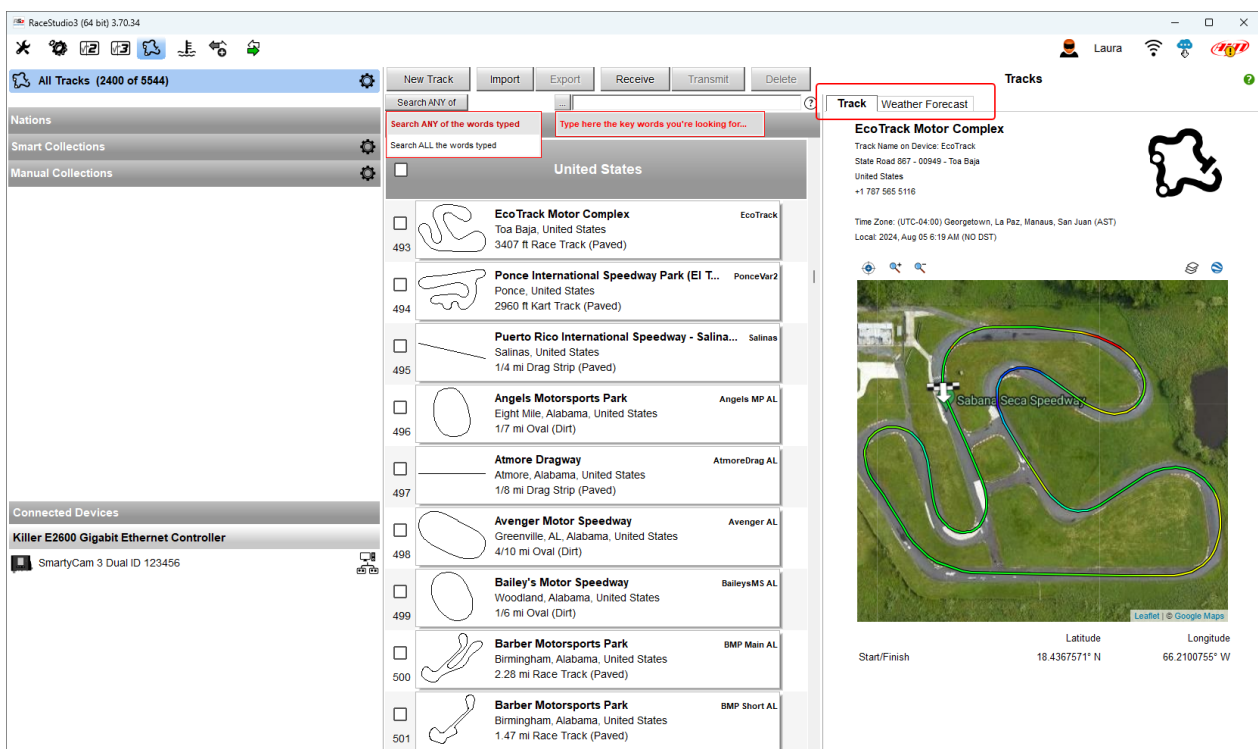



SmartyCam 3 (or its card) is shown left bottom of the page; clicking it an additional tab is prompted in the right column and tracks stored in the camera or in the (Micro) SD are shown. Tracks created by the user are labelled "User"; any difference among tracks stored and the same track included in AiM database is notified.

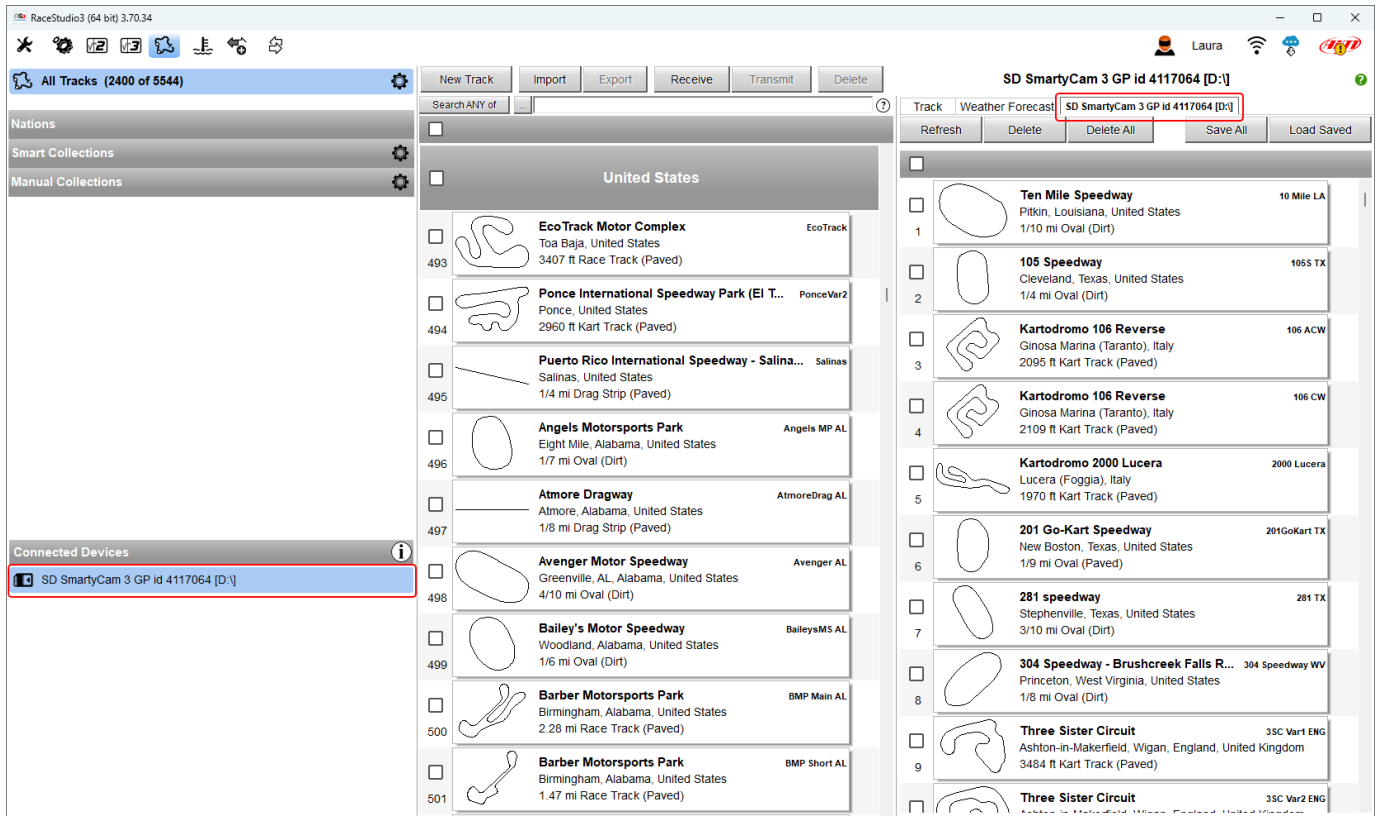

The page keyboards are for:



- **NewTrack:** creating a new track
- **Import:** importing one or more tracks stored in SmartyCam 3 or on another external device
- **Export:** exporting one or more tracks to a specific PC folder or to another peripheral device
- **Receive:** receiving from SmartyCam 3 the tracks created by the user (if no device is connected the button is disabled)
- **Transmit:** transmitting one or more tracks from the PC to SmartyCam 3 (if no device is connected the button is disabled)
- **Delete:** deleting one or more tracks from Race Studio 3 Database



- **Refresh:** refreshing the track list stored in SmartyCam 3
- **Delete:** deleting one or more tracks from SmartyCam 3 card
- **Delete All:** deleting all tracks stored in SmartyCam 3 card
- **Save all:** saving all the tracks stored in SmartyCam 3 card creating creates a zip file that can be loaded to another AiM device
- **Load Saved:** loading the tracks previously saved in SmartyCam 3 card.

8.4 – Video Management

Once a track session is over it is possible to review SmartyCam 3 video on a PC using the (Micro) SD (**all cameras**), the USB-C connection (**all SmartyCam3 except for SmartyCam 3 Sport**) or the Ethernet connection (**SmartyCam 3 Dual only**)

To manage video **using the (Micro) SD (all cameras)**:

- remove card from the camera
- place it in the PC slot and manage it as an USB peripheral
- run Race Studio3 software
- click on the card bottom left of the software page
- the list of the video stored in the card is prompted right of the page
- press “Download” button on the top keyboard
- fill in the panel that is prompted
- press “OK”

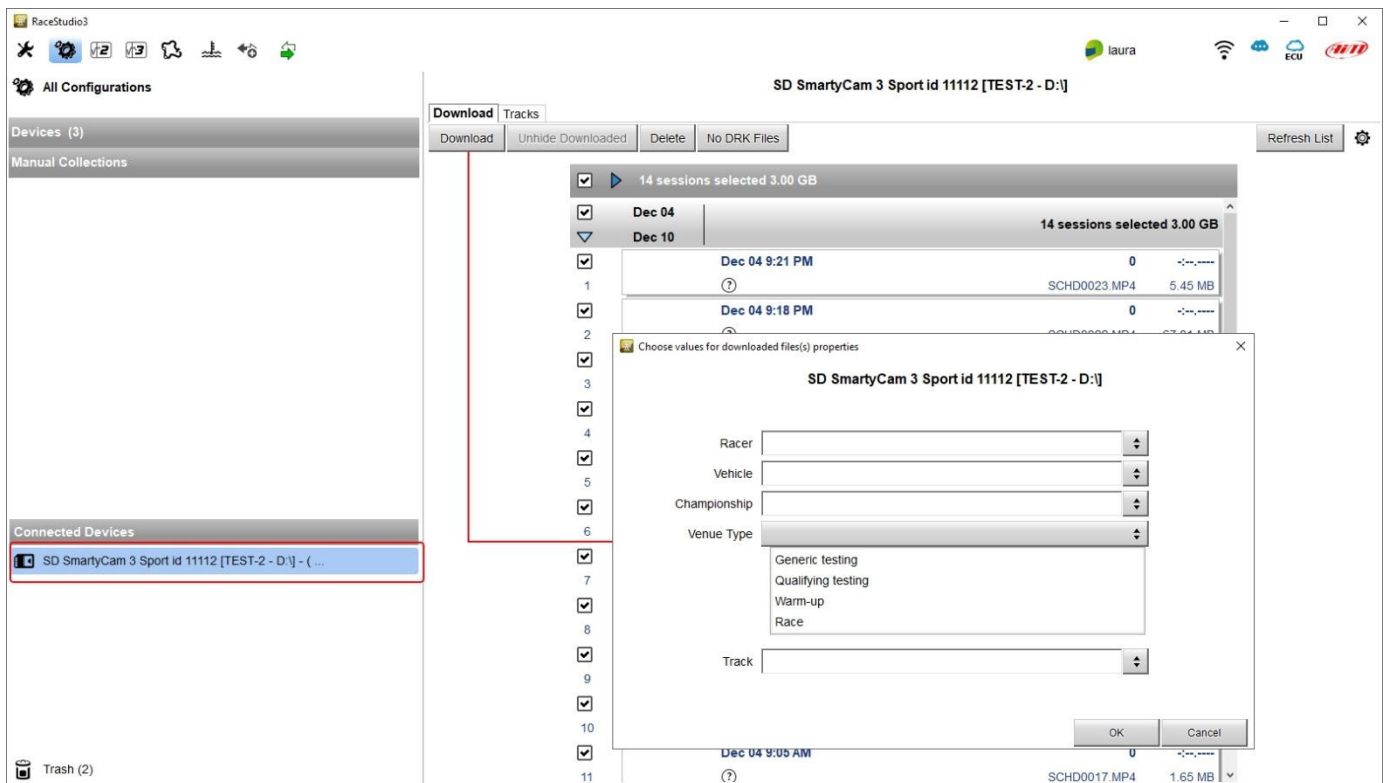

As said before **SmartyCam 3 Dual, SmartyCam 3 GP, SmartyCam 3 GP Pro and SmartyCam 3 Corsa** don't need to remove the SD from the camera slot. Using the USB-C cable or the Ethernet port (**SmartyCam 3 Dual only**) you can download the video file directly from the connected camera.

With SmartyCam switched on and connected simply press “Download” button and the file are downloaded on your PC.



Right of download view is a setting icon (in red here below). Clicking it a menu panel is prompted. Here you can:

- manage download settings
- format the (Micro)SD card
- switch to internal memory (**SmartyCam 3 GP Pro** only)

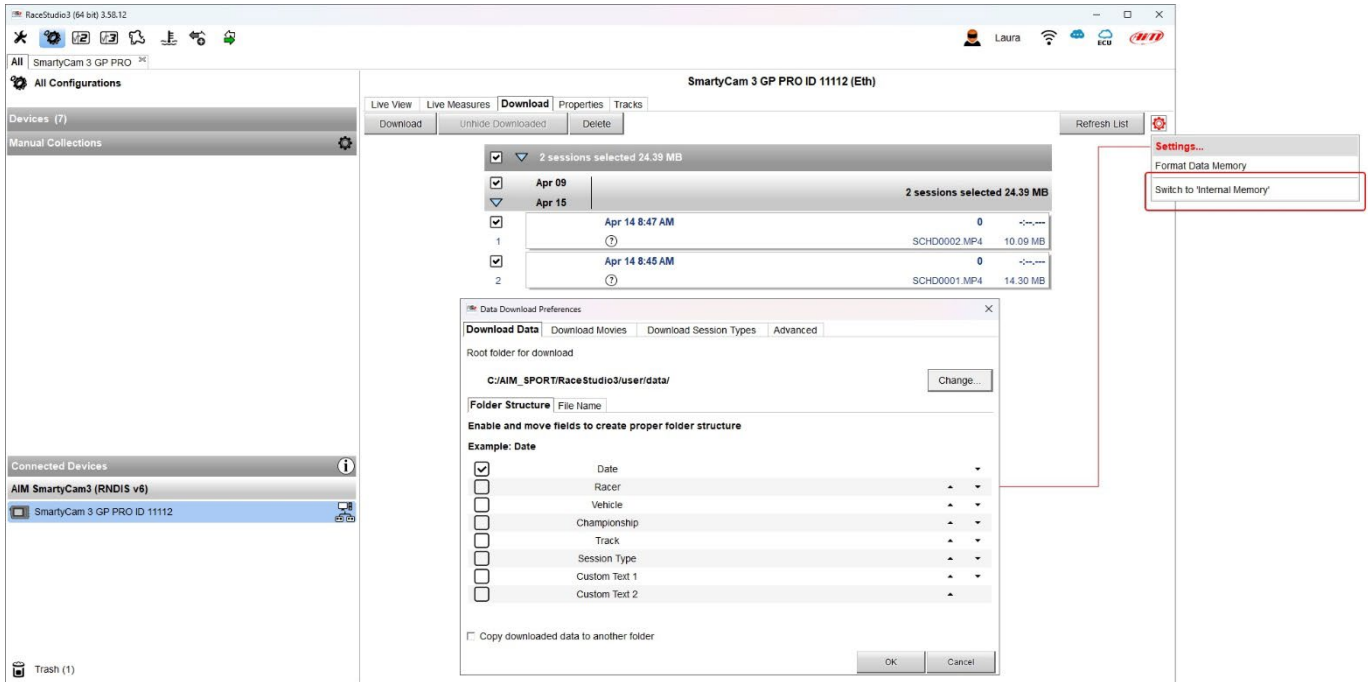

Pressing "download" button top of the view video download starts.

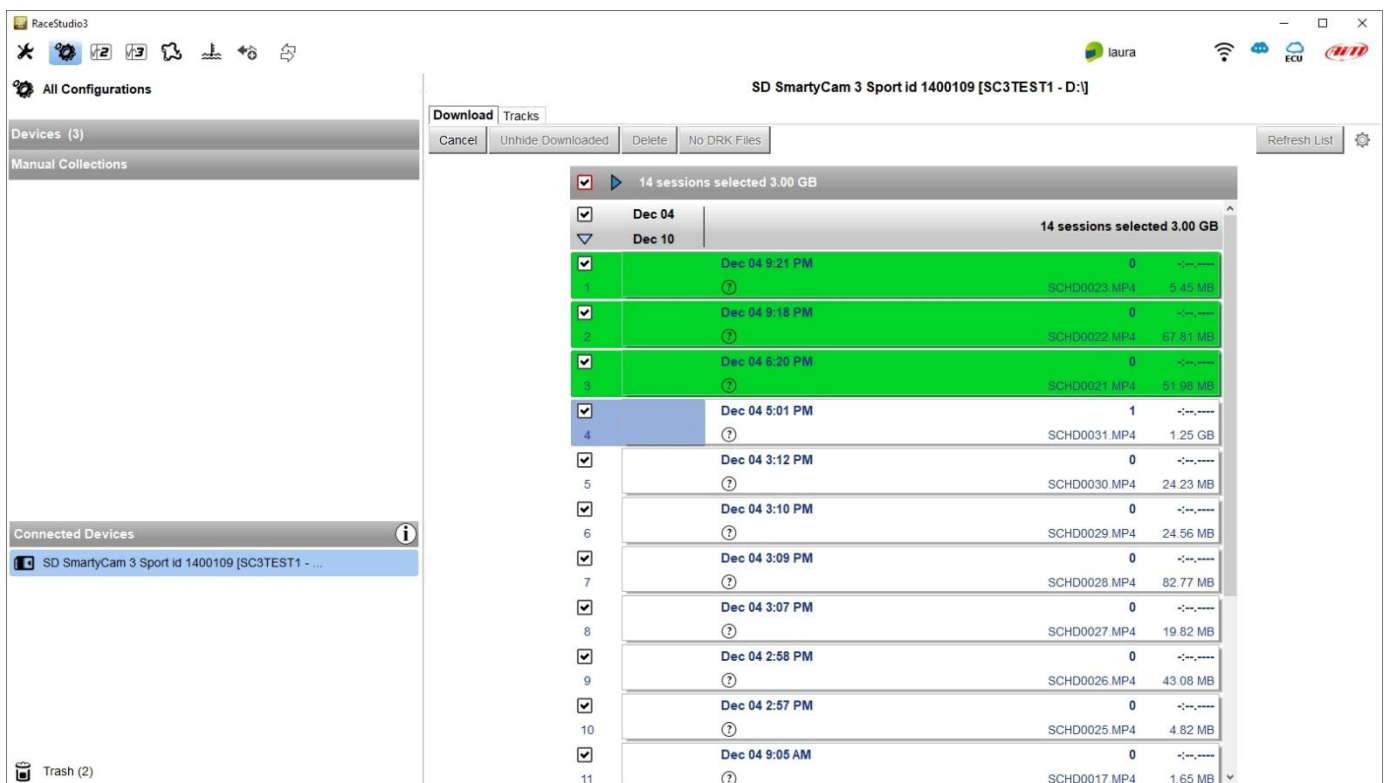



When all files have been downloaded run Race Studio3 Analysis and the video just downloaded are prompted in the central column of the page. Click on any video to start watching it.

Please refer to RaceStudio3 Analysis user manual for any further information concerning the software working mode.

The screenshot displays the RaceStudio3 software interface. On the left, a sidebar lists 'All Events (96 sessions of 96)' with columns for '#', 'Date', and 'Track'. Below this are sections for 'Recent Sessions', 'Smart Collections', and 'Manual Collections'. The main area is divided into two panes. The top pane shows a table of lap data for '2022, April 27'. The bottom pane shows a table of lap data for '2022, Apr 26'. To the right, a detailed view for '2022, Apr 27 3:12 PM (1 laps enabled)' is shown, including a table with columns for 'Lap', 'Time', 'Pct', 'Min', and 'Avg', and a line graph of 'GPS Speed (km/h)' vs 'Time [s]'.

#	Date	Track
0	2022, April 27	45,537°N, 9,335°E
1	2021, May 03	Dragster
4	2021, May 01	SMP DW
10	2020, November 27/28	Dragster
2	2020, October 03	Dragster AIM Test
9	2020, September 26	Dragster AIM Test
1	2019, July 16	Bristol DW
8	2019, July 13/14	
5	2019, July 06/07	
6	2019, June 22	
17	2019, June 15/16	
15	2019, March 22	
1	2019, January 24	Dragster
1	2019, January 17	Dragster
6	2017, September 08/09	Dragster
2	2017, September 02	Dragster

2022, Apr 27	Lap(s)	Best	Venue ... Racer	Vehicle Cham...	Track
3:12 PM	1	0:13.663	45,537...
3:10 PM	1	0:13.747	45,537...
1:47 PM	1	2:10.640	Laura	...	NO GPS
1:45 PM	1	2:05.674	Laura	...	NO GPS

2022, Apr 26	Lap(s)	Best	Venue ... Racer	Vehicle Cham...	Track
9:21 PM	1	0:03.090	NO GPS
9:18 PM	1	0:37.310	NO GPS
6:20 PM	1	0:29.045	NO GPS

Lap	Time	Pct	Min	Avg
1	0:13.6310	inf	0.2	1.0

GPS Speed (km/h) vs Time [s] graph showing speed fluctuations between 0.0 and 2.2 km/h over time.



9 – Technical specifications and drawings

9.1 – Technical Specifications

SmartyCam 3 Sport

Video format	H264 – 1920x1080 pixels at 30 fps
Display resolution	128x128 pixels
Lens	Low distortion camera lens
CMOS Sensor	Global shutter
Field of view	67° or 84°
External power	9-15V
Supported (Micro) Card (not included)	up to 2Tb
Connector	1 Binder 712 female
Working temperature range	-10°C/+50°C
Auto power ON	Yes
Auto power OFF	Yes
Auto Start/Stop recording	Yes
Body	Nylon fiberglass charged and coated aluminium
Dimensions	79.9x54x46.5
Weight	200g battery included
Waterproof	IP65

SmartyCam 3 Dual

Video format	H264 – 1920x1080 pixels at 60 fps
Display resolution	2,4" 240x320 pixels
Lens	Low distortion camera lens
CMOS Sensor	Global shutter
Field of view	67°, 84° or 120
Internal battery	rechargeable lithium battery
Video Output	3G-SDI
External power	9-15V
Supported SD Card (not included)	up to 2Tb
Connectors	1 Deutsch 22 pins 1 SMA SDI Video Out 2 SMA bullet connection 1 USB-C
Working temperature range	-10°C/+50°C
Auto power ON	Yes
Auto power OFF	Yes
Auto Start/Stop recording	Yes
Body	Aluminium
Dimensions	Main Unit 154.4x109.6x45mm bullet cameras diameter 24x48.2mm
Weight	Main unit 800g battery included bullet 45g each
Waterproof	IP65



SmartyCam 3 GP

Video format	H264 – 1920x1080 pixels at 60 fps
Display resolution	2,4" 240x320 pixels
Lens	Low distortion camera lens
CMOS Sensor	Global shutter
Field of view	67°, 84° or 120
Internal battery	rechargeable lithium battery
Video Output	3G-SDI
External power	9-15V
Supported SD Card (not included)	up to 2Tb
Connectors	1 Binder 7 pins 1 Binder 5 pins 1 SMA bullet connection 1 SMA SDI video output connection 1 USB-C
Working temperature range	-10°C/+50°C
Auto power ON	Yes
Auto power OFF	Yes
Auto Start/Stop recording	Yes
Body	Aluminium
Dimensions	Main Unit 120.8x80.2x30.9mm bullet camera diameter 24x46 mm (120° lens) bullet camera diameter 24x41mm (67-84° lens)
Weight	Main unit 320g battery included bullet 45g each
Waterproof	IP65

SmartyCam 3 GP Pro

Video format	H264 – 1920x1080 pixels at 60 fps
Display resolution	2,4" 240x320 pixels
Lens	Low distortion camera lens
CMOS Sensor	Global shutter
Field of view	67°, 84° or 120
Internal battery	rechargeable lithium battery
Video Output	3G-SDI
External power	9-15V
Supported SD Card (not included)	up to 2Tb
Internal EMMC	64GB
Connectors	2 AS micro Xtra lite HE 5ways Deutsch 2 SMA female 1 USB-C
Working temperature range	-10°C/+50°C
Auto power ON	Yes
Auto power OFF	Yes
Auto Start/Stop recording	Yes
Body	Aluminium
Dimensions	Main Unit 120.8x80.2x30.9mm bullet camera diameter 24x46 mm (120° lens) bullet camera diameter 24x41mm (67-84° lens)
Weight	Main unit 320g battery included bullet 45g each
Waterproof	IP65



SmartyCam 3 Corsa

Video format	H264 – 1920x1080 pixels at 60 fps
Display resolution	128x128 pixels
Lens	Low distortion camera lens
CMOS Sensor	Global shutter
Field of view	67° or 84°
Internal battery	rechargeable lithium battery
External power	9-15V
Supported SD Card (not included)	up to 2Tb
Connectors	1 Binder 7 pins 2 Binder 5 pins 1 USB-C
Working temperature range	-10°C/+50°C
Auto power ON	Yes
Auto power OFF	Yes
Auto Start/Stop recording	Yes
Body	Aluminium
Dimensions	102.2x63x46.5mm
Weight	280g battery included bullet 45g each
Waterproof	IP65

9.2 – Drawings

9.2.1 – SmartyCam 3 Sport

SmartyCam 3 Sport dimensions in mm [inches]

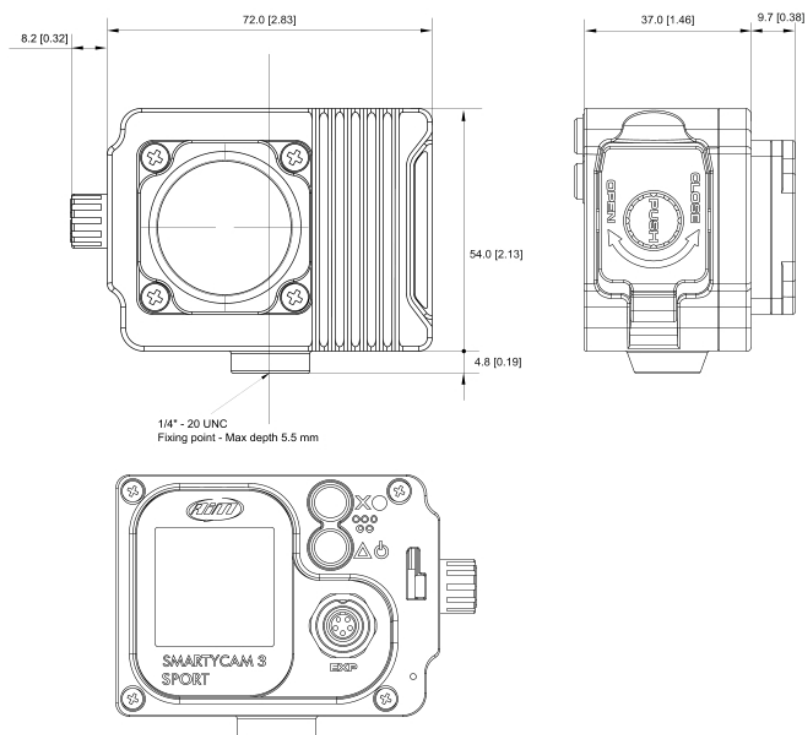

SmartyCam 3 Sport pinout

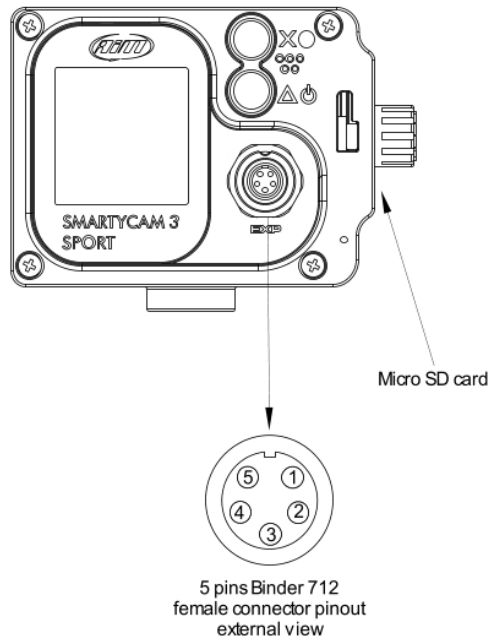

EXP	
1	CAN+
2	GND
3	+Vb out
4	CAN-
5	+Vb ext

9.2.2 – SmartyCam 3 Dual

SmartyCam 3 Dual Dimensions in mm [inches]

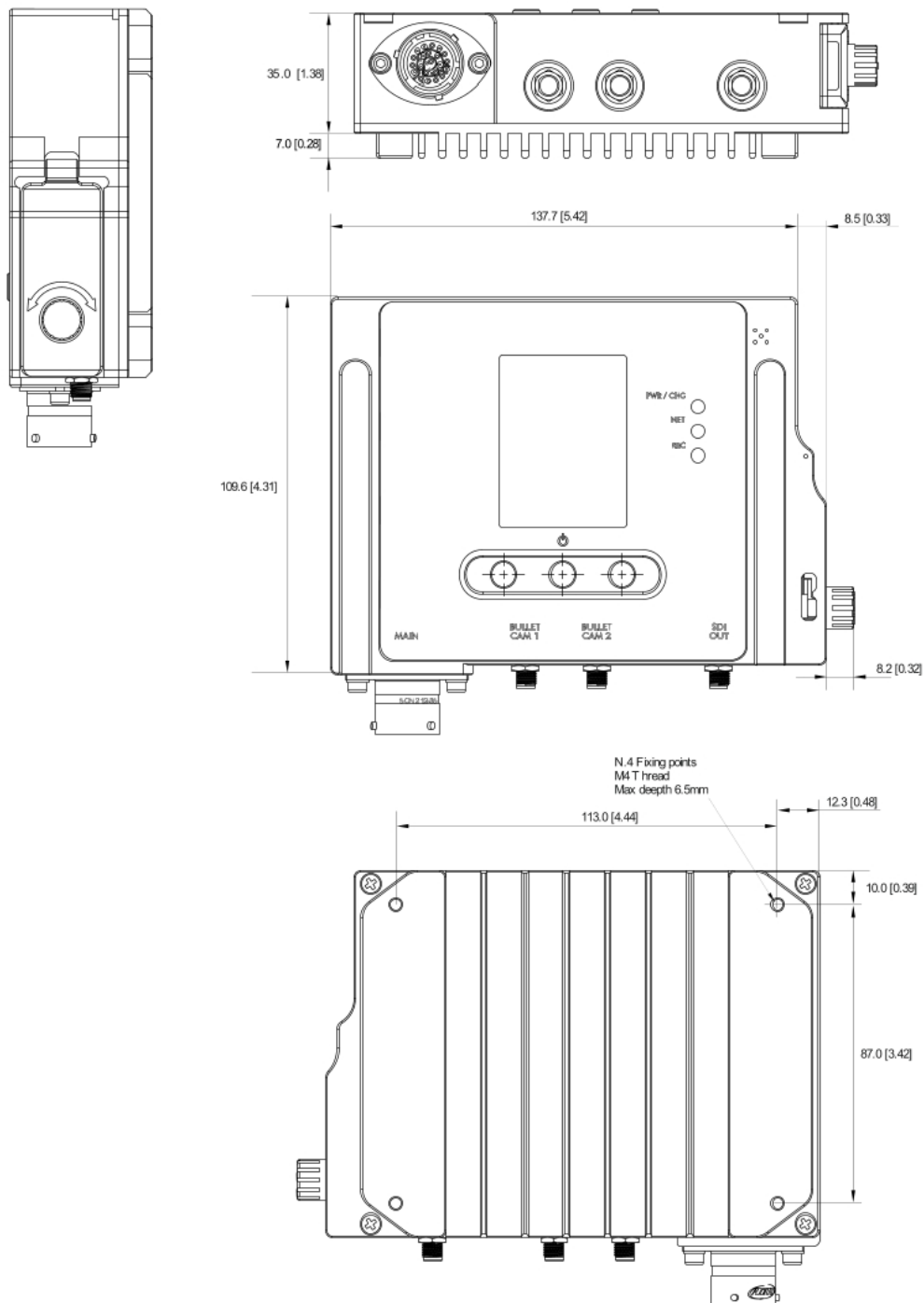

SmartyCam 3 Dual pinout

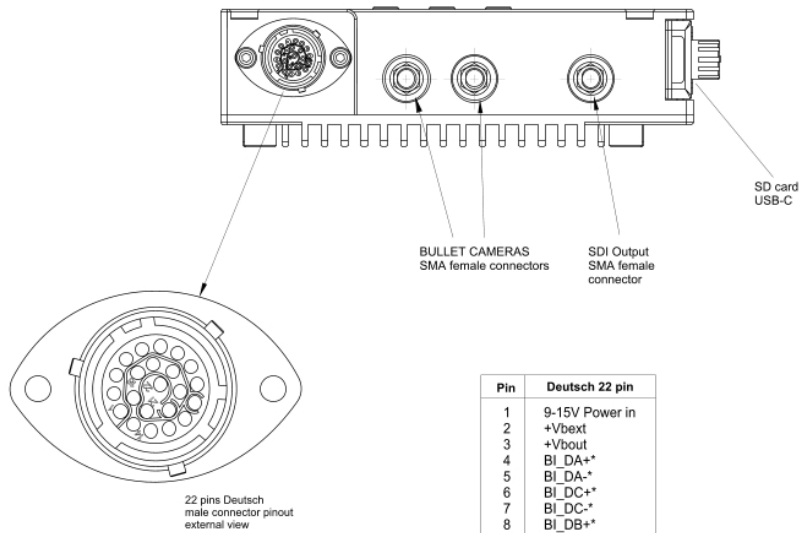

Pin	Deutsch 22 pin
1	9-15V Power in
2	+Vbext
3	+Vbout
4	BI_DA+*
5	BI_DA-*
6	BI_DC+*
7	BI_DC-*
8	BI_DB+*
9	BI_DB-*
10	GND
11	GND
12	Not connected
13	ECU CAN-
14	Ext MIC-
15	Ext MIC-
16	AIM CAN-
17	AIM CAN+
18	BI_DD-*
19	BI_DD+*
20	GND
21	ECU CAN+
22	Not connected

* Ethernet



SmartyCam 3 Dual Standard harness (part number V02584300)

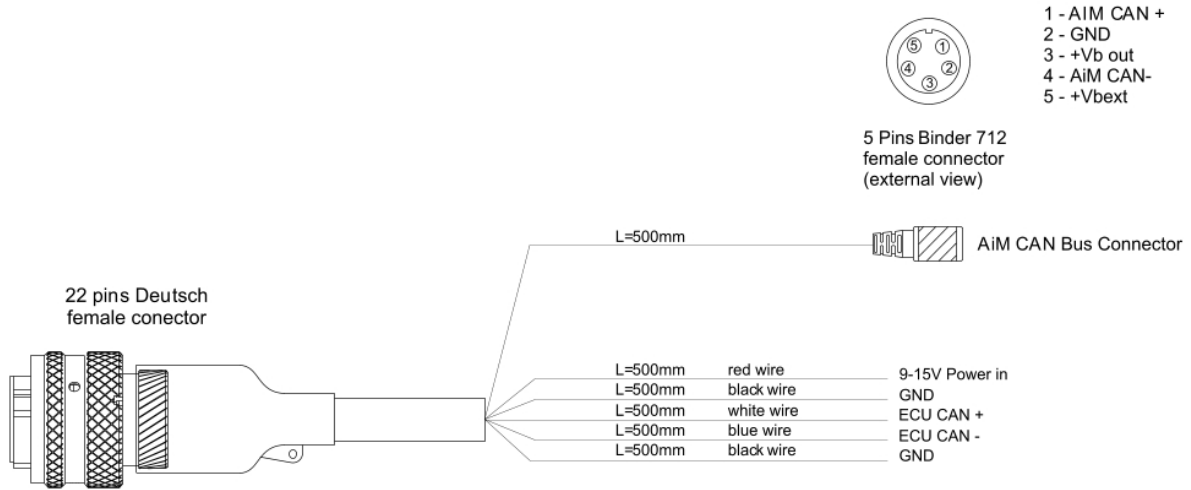

SmartyCam 3 Dual Standard+Ethernet harness (part number V02584350)

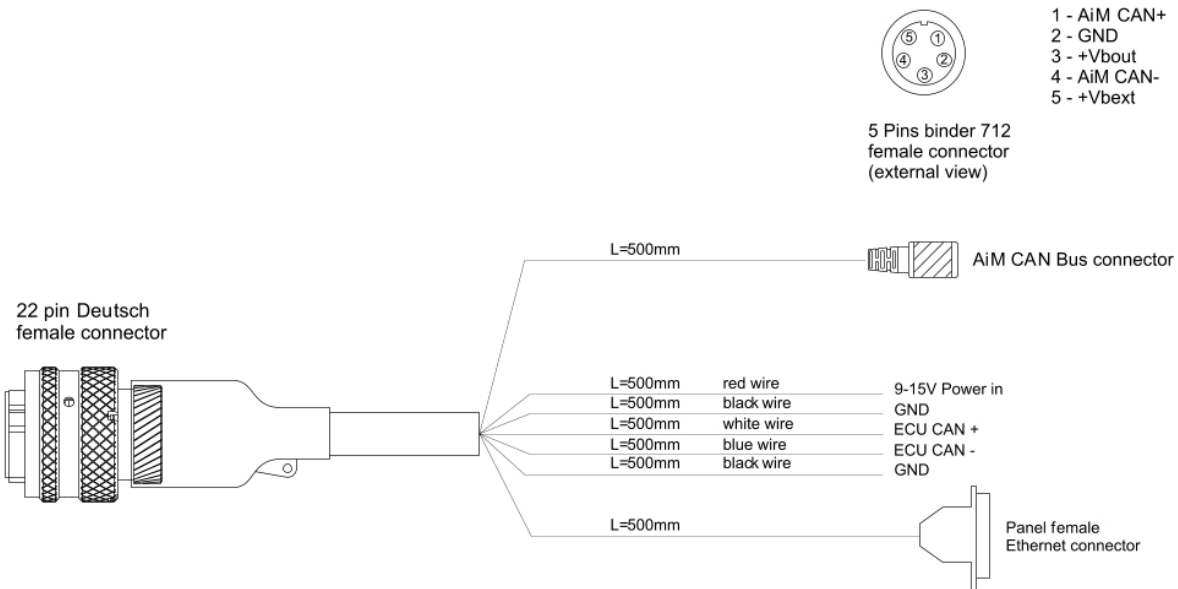



SmartyCam 3 Dual Full harness (part number V02584290)

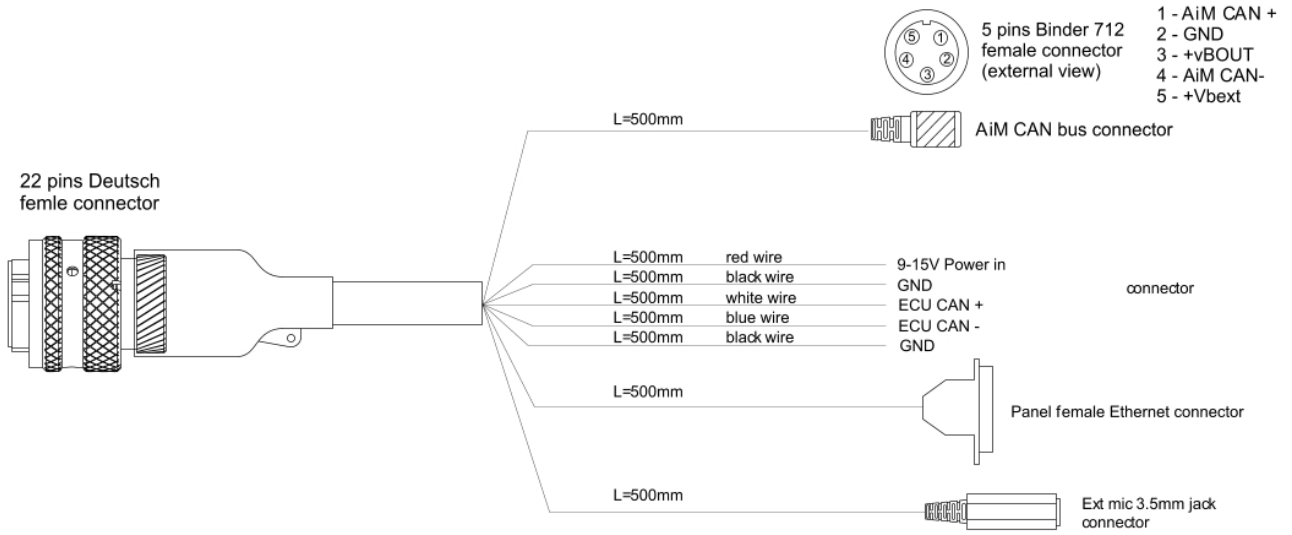

9.2.3 – SmartyCam 3 GP

SmartyCam 3 GP dimensions in mm [inches]

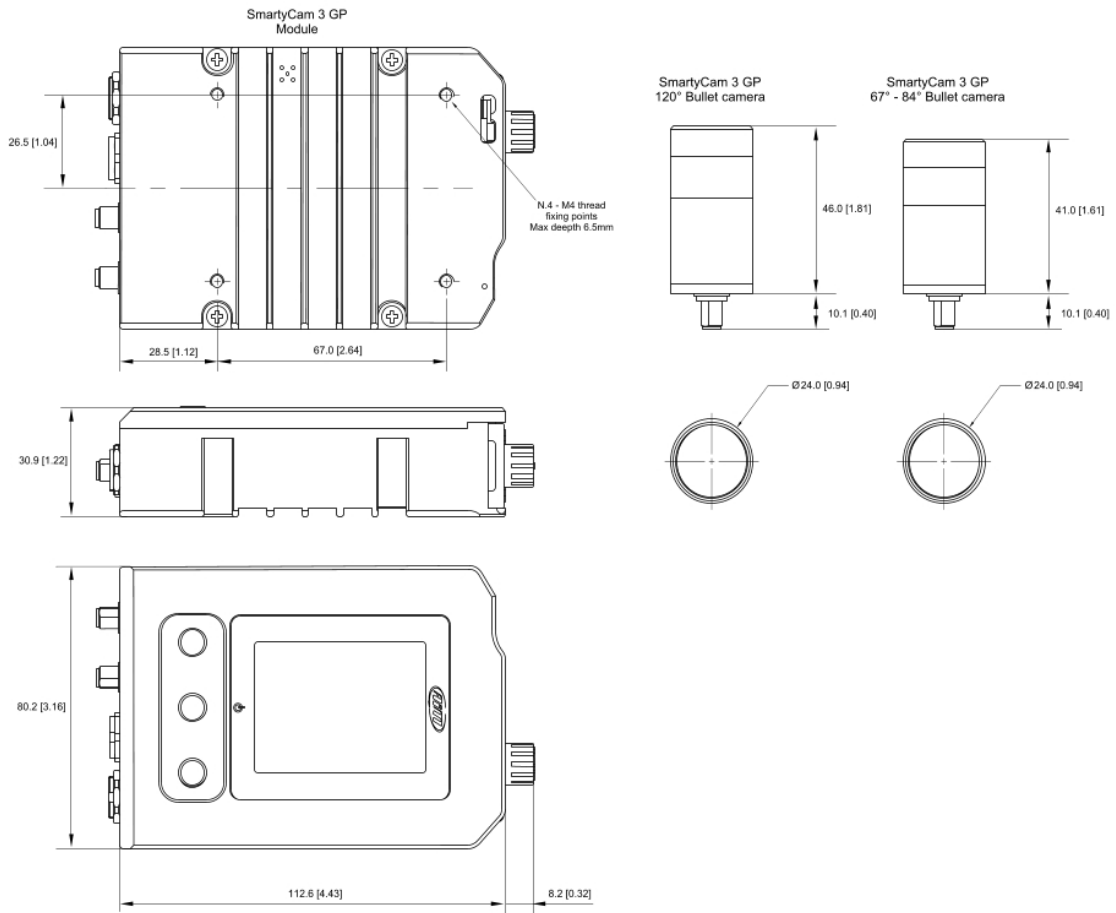

SmartyCam 3 GP Pinout

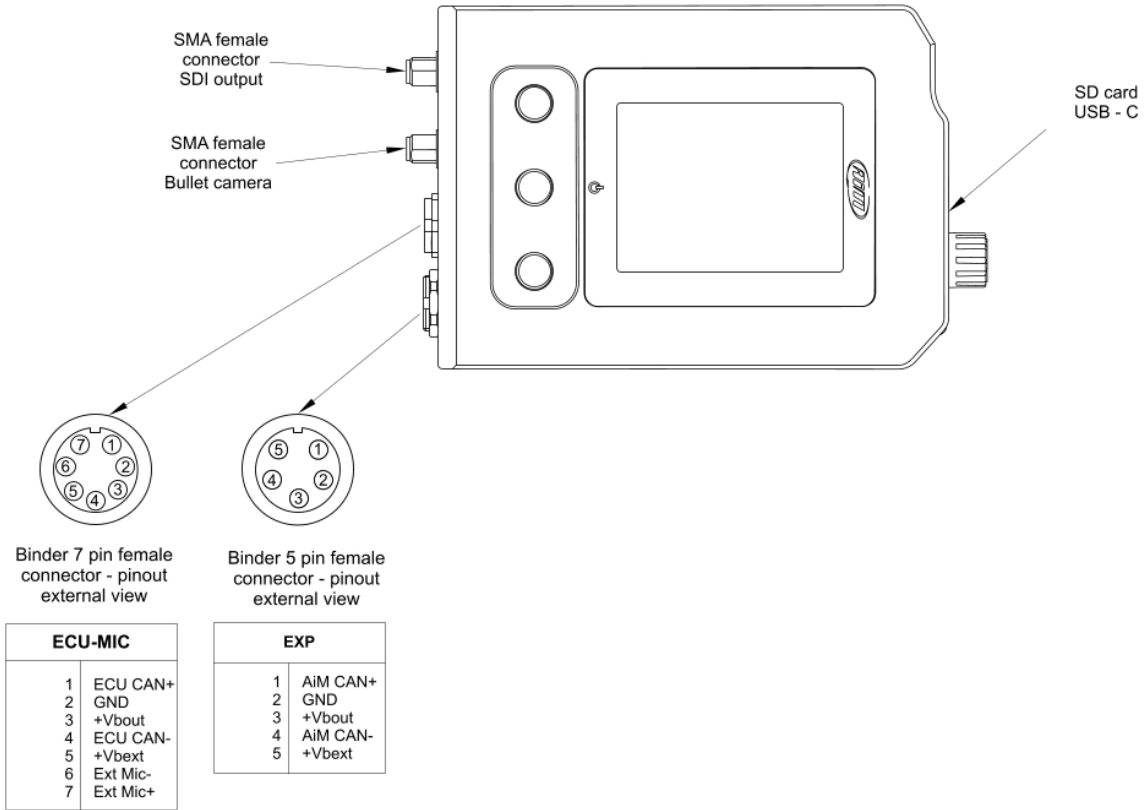

SmartyCam 3 GP cable with Jack for external microphone (part number V02584040)

Cable with Jack for external microphone for SmartyCam

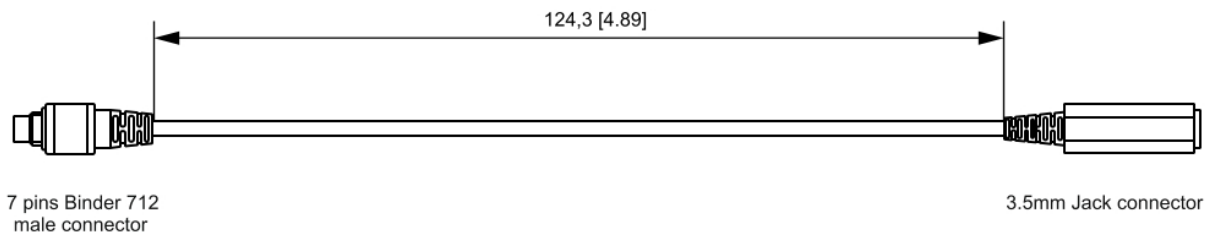

SmartyCam 3 GP cable with CAN adapter, external power and jack for external microphone (part number V02584140)

CAN ECU + Jack for external microphone for SmartyCam

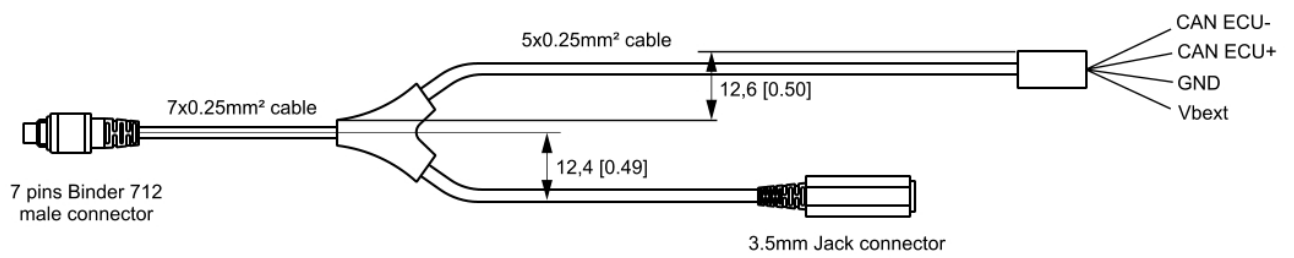



9.2.4 – SmartyCam 3 GP Pro

SmartyCam 3 GP Pro dimensions in mm [inches]

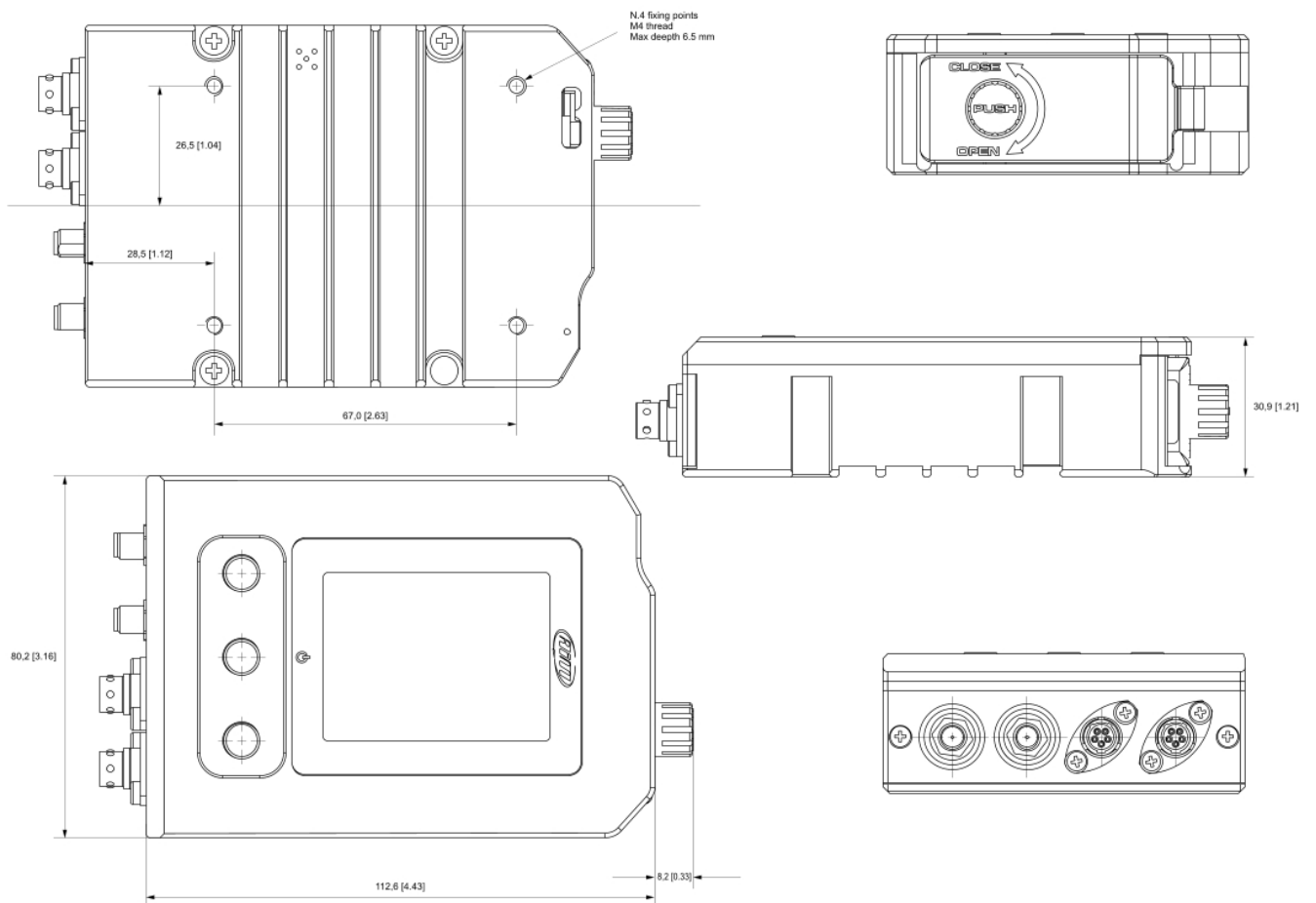

SmartyCam 3 GP Pro pinout

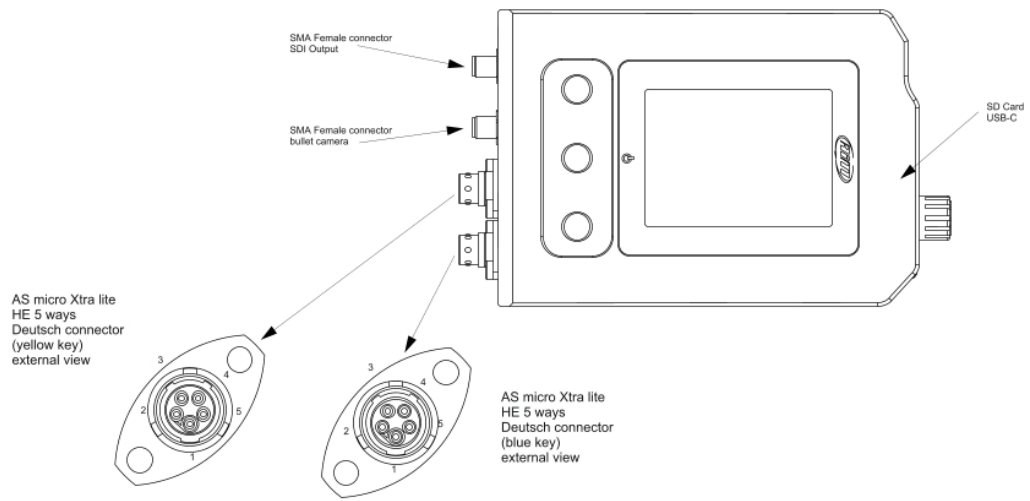

ECU	
1	CAN ECU+
2	GND
3	+Vbout
4	CAN ECU-
5	Vbext

EXP	
1	CAN AiM+
2	GND
3	+Vbout
4	CAN AiM-
5	Vbext

9.2.5 – SmartyCam 3 Corsa

SmartyCam 3 Corsa dimensions in mm [inches]

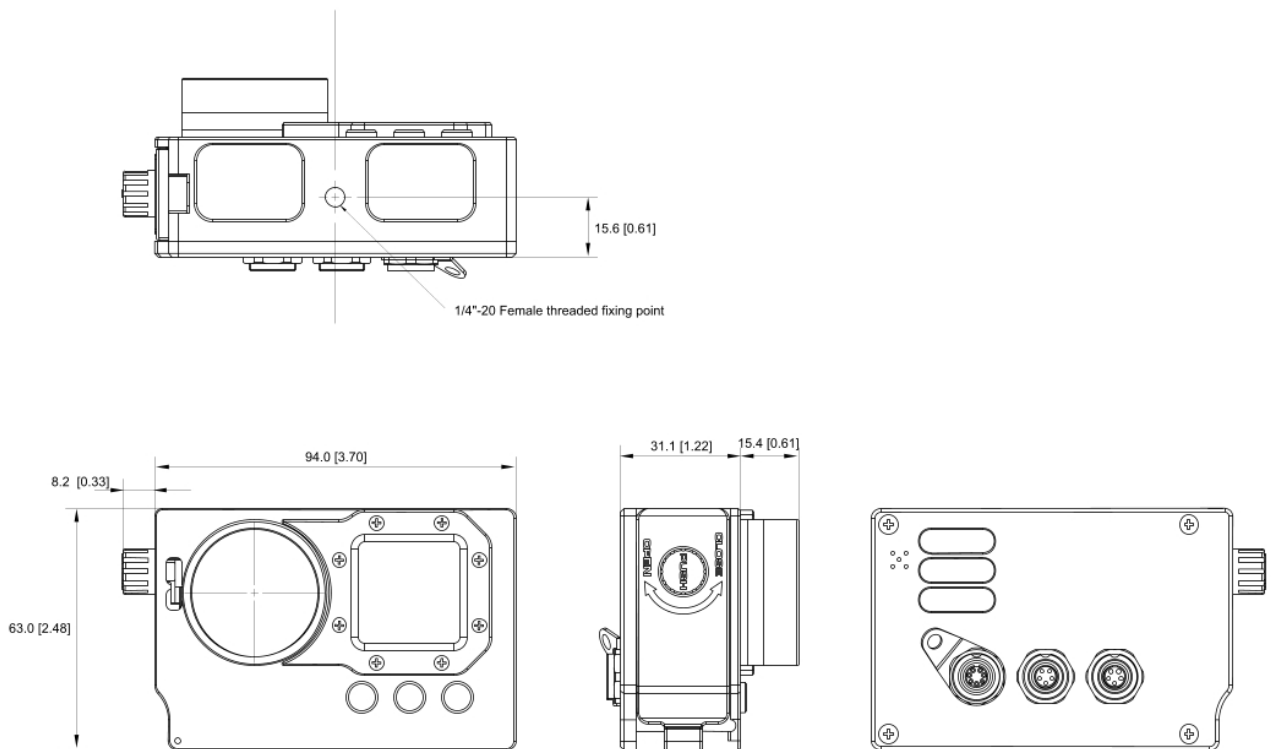

SmartyCam 3 Corsa Pinout

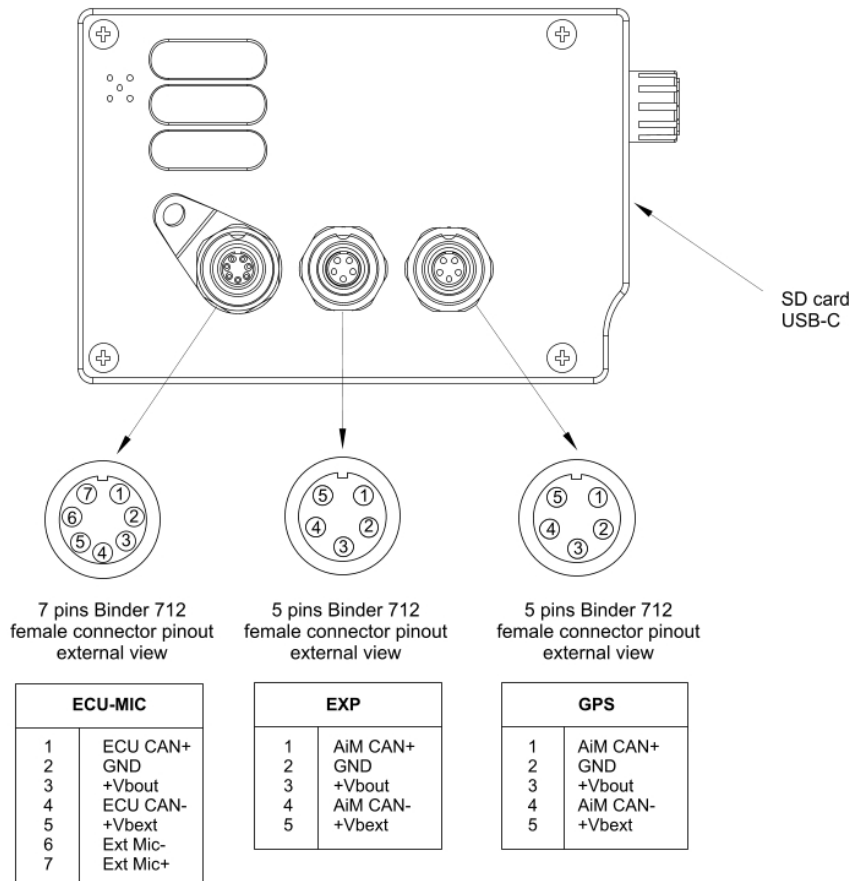

CAN cable for SmartyCam 3 Corsa (part number V02.554.820)

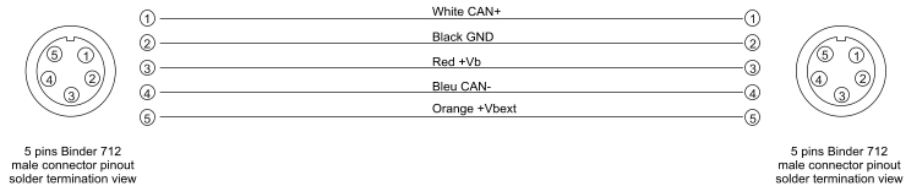
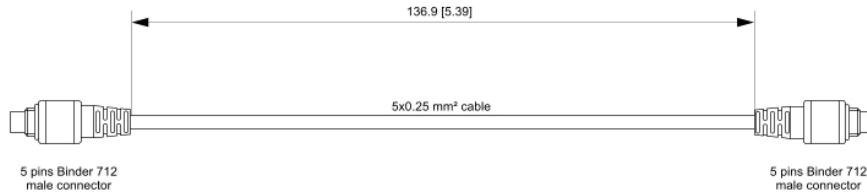

CAN+ECU cable for SmartyCam 3 Corsa (part number V02.566.930)

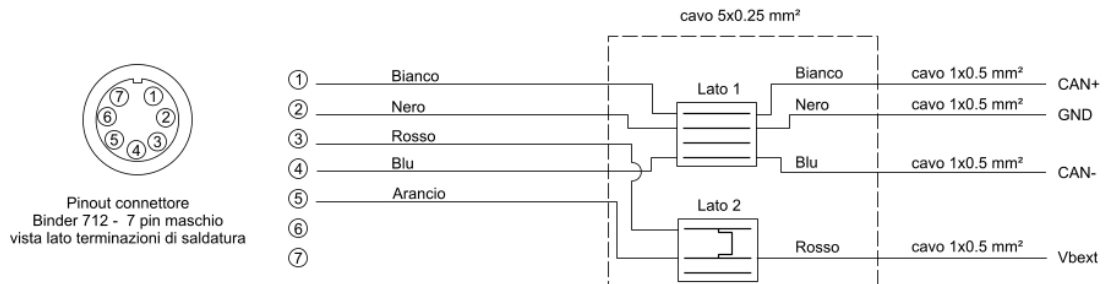
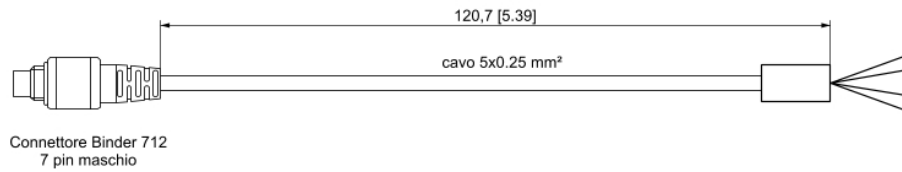

SmartyCam 3 GP cable with Jack for external microphone (part number V02584040)

Cable with Jack for external microphone for SmartyCam

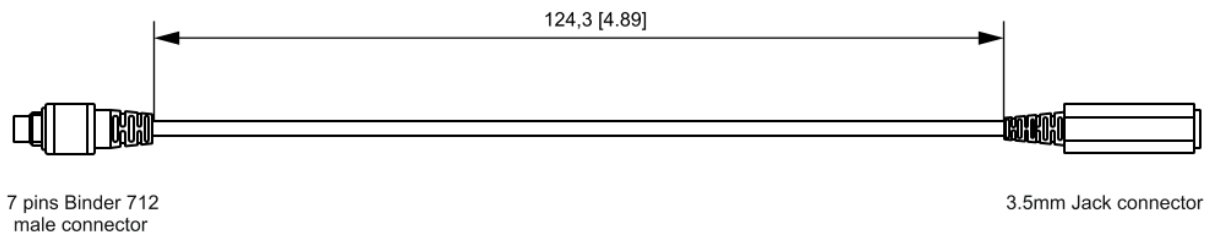

SmartyCam 3 GP cable with CAN adapter, external power and jack for external microphone (part number V02584140)

CAN ECU + Jack for external microphone for SmartyCam

